



VAPoN™ Resource Book

Value Added Printing of Newspapers

connection of competence





Primary contributors and project sponsors

Eltex *Lukas Hahne*
 Trelleborg Printing Systems *Anne Unterfingher*
 manroland *Ralf Henze, Sabine Sirach*
 MEGTEC Systems *Andreas Keil*
 Océ *Christoph Gauss*
 Sun Chemical *Paul Casey (Project Leader), Gerry Schmidt, Bob Greenslade*
 UPM *Hans-Joachim Kölln, Martin Schorn*
 Editor and Project Manager *Nigel Wells*

Other contributors

Eltosch *Georg Enste*
 Böttcher *Graham Macfarlane*
 DELO d.d *Ljubljana, Ivo Oman, Marko Kumar*
 Eurografica *Stephan Müller*
 ESI *Urs Läubli*
 Herold Druck und Verlag AG, Vienna
Thomas Unterberger
 Ifra *Manfred Werfel, Andy Williams*
 Passauer Neue Presse Druck, Passau,
Karlheinz Dürr
 Swansea University *Dr Tim Claypole, Eifion Jewell*

VAPoN value assessment survey participants included:

Suomen Lehtiyhtymä Oy - Finland
Kustannus Oy Aamulehti - Finland
Sanomapaino; Sanomala Oy - Finland
Turun Sanomat Oy - Finland
Pressedruck Augsburg - Germany
SHZ Schleswig-Holsteinischer Zeitungsverlag GmbH - Germany
PCM Grafische Bedrijven BV - Holland
Ringier Kiado Kft - Hungary
Lapcom Kft - Hungary
PLT Nyomdai Központ Bt - Hungary
Lokmat Newspapers PVT.LTD - India
The Hindu - India
Il Sole 24 Ore - Italy
Athesis - Italy
Poligrafici Editoriale - Italy
CSQ - Italy
V-TAB Västerås - Sweden
Ringier Print Zofingen AG - Switzerland
Tamedia AG - Switzerland
NZZ - Switzerland
Druckzentrum Espace Media - Switzerland
Trinity Mirror Group - UK
News International Newspapers Ltd - UK
The Milwaukee Journal Sentinel - USA
New York Times - USA

Selected bibliography and recommended reading

“How to avoid surprises when changing paper grades”
Web Offset Champion Group, 2001
 “Hybrid Houses” *Newspapers & Technology, 2006*
 “Innovations in Newspapers”
Innovation International Media Consulting Group/WAN, 2005
 “Making the Leap Beyond Newspaper Companies”,
Newspaper Next 2.0, American Press Institute, 2008
 “Market study on inserts”
Zeitungs Marketing Gesellschaft, 2001.
 “Newspaper Advertising of ROP, inserts and coupons”
Newspaper Association of America, 2001
 “Outlook and trends for the future of Newspapers”
GAMIS/PIA & Kubas Consultants, 2000
 “Optimised Sheetfed UV” *PrintCity 2008*
 “Total process colour control & Alternative Screening Technologies”
Web Offset Champion Group 2008.
 “US Newspaper Publishing”
Pricewaterhouse Coopers, 2001
 “UV Sheetfed Printing & Coating Best Practices Guide”
PrintCity, 2008
World Press Trends 2006.
Deutscher Drucker No.3/1.2, 2007.

IFRA special reports:

“Investment in Press and Mailroom”
Ifra Special Report 3.34
 “Inserting impacts more than just the mailroom”
Ifra Newspaper Techniques, 2002
 “Better usability of newspaper presses” (3.6 & 3.10)
 “The efficiency of register control systems in newspaper printing” (3.23)
 “Better news ink or better newsprint to reach less set-off and rub-off?” (3.24)
 “Reasons for smearing, set-off and rub-off of offset inks on newsprint” (3.26)
 “Improving the print quality with dryers and better paper grades” (3.27)
 “How to run coated paper in a newspaper press”
 “Dryers to improve newspaper colour quality, flexibility and capacity utilisation”
IFRA conference Düsseldorf, June 1997

World Association of Newspapers — Shaping the Future of the Newspaper, reports:

4.5 “The Format Change Phenomenon” 2005
 5.5 “Advertising Science” 2006
 5.2 “Outsourcing” 2006
 6.1 “New Print Products”, 2006;
 7.1 “Envisioning The Newspaper 2020”, 2007

© Copyright PrintCity GmbH + Co. KG. 2008, all rights reserved.
 'PrintCity', the PrintCity logo, 'Weblines' and 'VAPoN' are trademarks of PrintCity GmbH + Co. KG

Design and page make-up: ID Industry, Paris

Printing & Binding: Augsburg Druck- und Verlagshaus, Augsburg

Inks: Sun Chemical

Paper: Text 115 gsm UPM Finesse



Why Value Added Newspapers ?

“Whilst the number of titles and total circulations are on the upswing, the era of the one-size-fits-most newspapers is on the decline in many parts of the world. A new era is dawning, and it is about launching new, innovative products.”

— “New Print Products” World Association of Newspapers 2006

Innovative newspaper products need to add value to the publisher, advertisers and readers. Value can be any combination of higher revenue, circulation, differentiation or reader satisfaction.

PrintCity has defined Value Added Printing of Newspapers — VAPoN™ — as a newspaper product that is VISIBLY DIFFERENT to standard coldset; that is RECOGNISED by readers and advertisers; capable of attracting HIGHER REVENUES to the newspaper; and/or adds to its differentiation.

There are a multiple dimensions in which value can be added — usually the most effective strategy is to combine several of them. These can include improvements to content, design, layout and structure; quality of paper and reproduction; changes to physical size; special folds; bound and trimmed products; inserts and distribution methods. There is no one-size-fits-all solution for newspaper products and their production; rather, there is a large menu of options from which to select and combine to provide the right solution for a specific publishing company in its specific market dynamic.

This PrintCity cross-industry project report combines expertise across the value and process chain from its members, partners and other experts. Its objectives are to share knowledge of marketing, technical and economic issues. Its goal is to help identify business opportunities that increase revenue and differentiation, and to assist investment planning. The project focuses expertise on printed products and processes rather than proprietary technologies — unless they have some unique characteristic — within the context of the newspaper value chain.

The recent transition of VAPoN from a niche strategy to mainstream interest is driven by three related challenges:

- 1. Media and revenue competition** — Finding responses to the post-Internet media landscape.
- 2. Industry structure** — Retention of production as a profit centre, or outsource it to commercial printers.
- 3. Technology evolution** — One production process no longer satisfies all demands. What can be done now and in the future to change the value equation of newspaper production.

PREPRESS



POSTPRESS

PAPER-INKS-PRINTING

FORMATS

There are multiple dimensions in which value can be added to the newspaper publisher, advertisers and readers — usually the most effective strategy is to combine several of them.

CONTENTS	PAGES
Executive Summary	2
Market Trends & Trendsetters	4
Comparative Value Assessment	8
New Revenue Opportunities	10
VAPoN Printing Dimensions	12
Ink Systems	14
Newspaper UV systems	16
Heatset	20
Digital	22
Comparative Economics	24
Technical-Economic Summary	28
Other VAPoN dimensions	30

Executive Summary



A series of seven editions of the same newspaper were printed on different papers by different print processes as part of an international quality and value assessment combined with a survey of trends.

“The demise of the newspaper has been greatly exaggerated. In fact, the world has never seen so many daily newspapers – now numbering more than 10 000. A new global newspaper trend is emerging – replacing the “one-size-fits-most” newspaper model with newspapers focused on targeted audiences. As a result, newspapers are boosting their market share, circulations and advertising revenues.”

“Total free daily circulation worldwide has more than doubled from 2001 to 2005 to 28 million, an increase of 137%. This growth should be seen as positive and rife with revenue making opportunity. Three key trends are shaping the print newspaper landscape worldwide:

1. A proliferation of new genres of newspapers
2. The surge of new, free titles thrust into the paid-for market
3. The trend of the shrinking newspaper format.”

“New Print Products” World Association of Newspapers 2006

Broad VAPoN product range

Industry research indicates that future newspaper opportunities will come from continuous product enhancements — more than half of these are related to Value Added Printing (*):

- Brand name leadership, improved design
- More flexibility, topicality, target group orientation
- Special interest supplements and magazines*
- Preprinted advertising inserts*
- More regional editions and distributed printing
- Cross-media promotion and services using the Internet
- Better readability*
- More and better ROP (Run-of-Press) colour for premium advertising*
- Upgraded paper*
- Newspaper covers with high point-of-sale impact and without marking*
- Sections for premium double-page and cover ROP advertising*
- Unusual folds and other special effects*

Supplements & advertising inserts

Preprinted advertising and editorial sections inserted into the newspaper jacket provide many publishers with their strongest growth. Preprinted advertising revenue of US daily and Sunday newspapers outstripped ROP advertising in 2001 and average annual growth is around 10-12% compared to 0-2% for ROP. A major problem for publishers is that they generally only retain 40-60% of insert revenue because most are produced by external printers. According to WAN's “Innovations in Newspapers 2005” the best defence that newspapers have is to bring their own print quality closer to the standards of commercial printers.

Added Value & Revenue Opportunities

Improved quality must be related to what revenue or competitive advantage can be generated from them to build a business case for their deployment. PrintCity's VAPoN team made an international quality and value assessment using a series of seven editions of the same newspaper printed on different papers by different print processes. These have been assessed by newspaper staff around the world who determined their potential revenue premiums for ROP advertising over standard newsprint. The average premium ranged from 20-34% — a range similar to the previous value added step to 4-colour advertising that attracted a 31-37% revenue premium over 1-colour. The corresponding total production cost analysis indicates that these should be low enough to generate additional margins.

The VAPoN golden triangle for new revenue sources — all three potential sources of new revenues use the same value added production systems. Source PrintCity.

Potential newspaper revenues related to VAPoN techniques include:

- 1: Insourcing — Newspapers bring in-house some or all of the work produced externally, including advertising preprints, magazines and inserts.
- 2: Commercial printing — Many newspapers have successfully entered the commercial printing market by selectively targeting low-mid quality advertising and publications.
- 3: New publishing printed products — to increase share of advertising from other media (magazines,

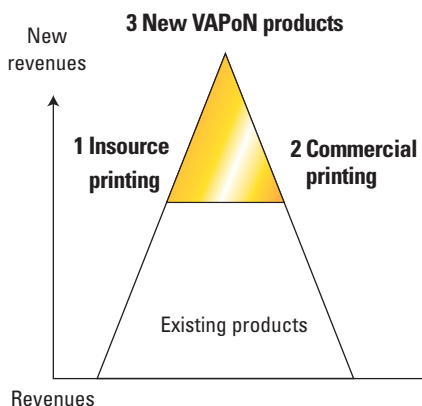

The VAPoN golden triangle for new revenue sources. Source PrintCity.

inserts, direct mail or private distribution systems). Laws restricting junk mail are an opportunity for newspapers to increase share because advertising material is more acceptable when bundled into the newspaper. According to WAN research, there is a direct link between the perceived quality of a newspaper and its cover price flexibility. Ideally, a business strategy should integrate each of these additional revenues opportunities to determine the optimum market and technical production solution required. Probably the single most important success factor is an entrepreneurial business strategy with effective sales and marketing implementation. Delivering a technical solution to fit the business strategy is comparatively simple and predictable.

Industry Structure

“Who will print the newspaper of tomorrow? The publisher will subcontract with a commercial printer who will produce the newspaper for him on a standard DIN format, customised wholly or partially in a heatset process on glossy paper, stapled, trimmed and combined with other publications such as magazines, supplements and special edition brochures. Newspaper printing machines will no longer be specialised but will aim at covering a third of the total printing market.”
 — Manfred Werfel, Ifra Research Director Deputy CEO, 2007

The previously separate newspaper and commercial printing operations — and their technologies — are increasingly converging. Publishers now have three structural options:

- Vertically integrated production as profit centres
- Alliances with other publishers to run joint production facilities
- Outsourced production to a commercial company on a contract basis.

High capital investment in presses and mailrooms requires better capacity utilisation from additional production this has led many newspaper printers to equip their presses with dryers since the 1990s. The changing industry structure and new technologies have converged into a new printing category sometimes called “selected” or “semi” commercial. This is defined by Ifra and PrintCity as “printing on a newspaper press equipped with a dryer” to print low to mid quality commercial work, inserts, magazines, directories and some newspaper products. Ifra has developed a specific new standard for this category of printing printing. Jobs of high quality, on heavy papers, or with unusual folds will remain the domain of commercial heatset printing.

Technologies

Value added is not simply about paper-ink-process technologies (although this is a main focus of this report). Rather, it is the combination of a number of different elements from prepress to postpress, paper, special formats and folds.

The relationship between paper and ink drying systems determines the type of papers that can be printed, printing quality and total operating costs. While 4-colour coldest on newsprint is now almost standard, it can no longer satisfy all of the evolving production demands. It will be increasingly complemented by other paper grades and ink systems that better respond to value added opportunities and demands.

Some technical-economic conclusions

This report’s technical-economic evaluation shows that there is no single technology solution for all newspaper applications. There are several options, each with strengths and weaknesses for potential success or failure in a given market environment.

Broad indications of current performance are:

- Coldset printers can increase product quality without capital investment by using matt coated paper.
- An interesting low capital cost process may be Coldset Overprint Coating that is currently under development.
- Heatset remains the mature solution for printing on all papers and has the lowest total cost of printing compared to UV or EB.
- Compact UV systems excel for retrofitting drying systems in limited available space and/or restricted foundations. UV has the lowest capital cost but highest total print costs.
- Inert UV offers much better performance than Conventional UV— except for slow speed single width presses.
- Electron Beam (EB) is theoretically well suited to double-width newspaper production but there are currently no newspaper installations.
- Digital printing offers solutions for very short runs to complement offset; as well as being integrated in conventional offset presses to allow variable non-stop printing.

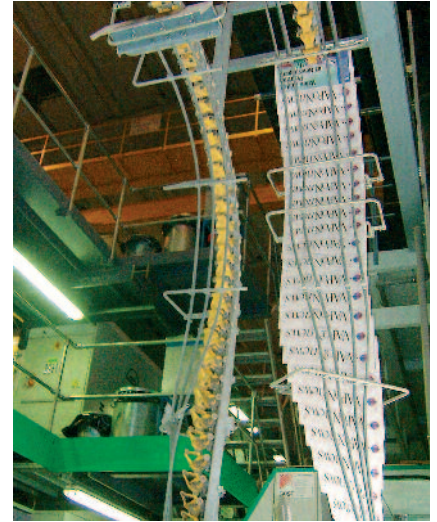

COLDSET

DIGITAL

HEATSET

UV/EB

There is no single technology solution for all newspaper printing applications.



Market Trends & Trend Setters

Respondents to the VAPoN survey were asked to rank the importance of trends in their market over the next three years. Their replies confirm those of other newspaper research in this area.

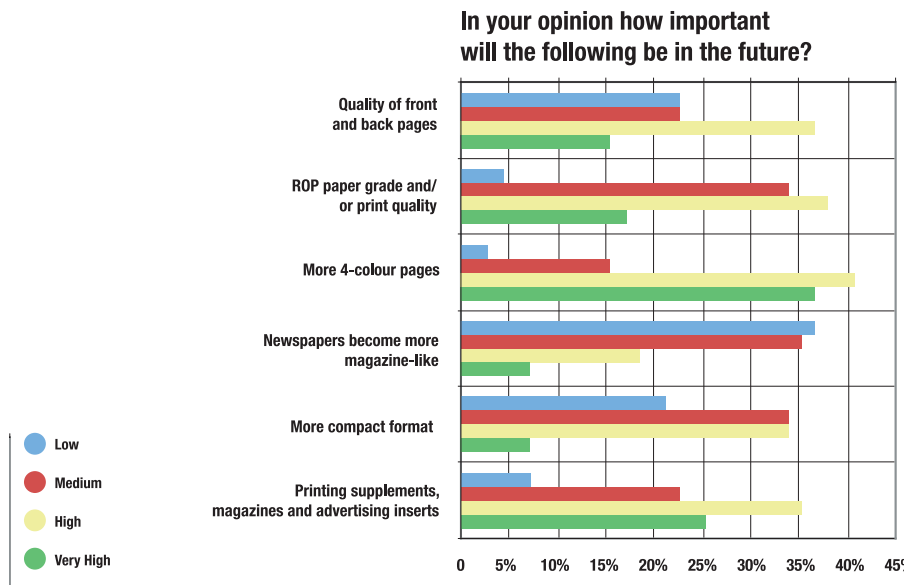

- More 4-colour pages was rated high to very high by over 80%. Implying that many of the newspapers concerned still have restricted colour capacity.
- Improved ROP paper grade and/or print quality are a high priority.
- Almost equally important is improved quality of front and back pages from either better paper, printing or higher gloss, and elimination of marking.
- High importance of magazines and advertising inserts.
- Changing to a more compact format is a medium to high priority.
- Newspapers becoming more like magazines was seen to be important by 25% — a significant minority.

Trend setters

Newspaper trend setters come from a variety of geographical and media environments. What most have in common is the use of newspaper presses upgraded with dryers to improve existing newspaper products and to create new ones. Most are also pursuing related insourcing and commercial printing opportunities with these technologies. However, some are outsourcing all of their production to commercial printing.

Australian hybrid pioneers Australia's competitive media environment and a culture of business and technical innovation largely explains the continent's leadership in producing differentiated newspaper products since the 1980s. The early adoption of hybrid heatset-coldset presses was driven by the creation of new newspaper products and commercial printing revenue. This approach is now widely used by many regional and free papers, and more recently by two daily titles.

Middle-East early adopters In addition to the early adopters, Gulf News and Khaleej Times, the latest example is Gulf Publishing & Printing Company's installation of a newspaper press equipped with four dryers to improve the quality of their daily newspaper and to attract new commercial customers.

Austrian Innovators The Austrian media market is hyper competitive with 17 daily newspapers serving a country of 8 million inhabitants. As a result, there is a high level of marketing and technology innovation that is demonstrated by two recent strategies. One is a completely new daily newspaper-magazine 'ÖSTERREICH' that uses an outsourcing production strategy; the other is by



Gulf News is a pioneer of VAPoN products whose daily newspaper features ROP heatset and coldset sections. Photo: manroland.

the integrated publisher-printer Herold Druck who are pioneering Inert UV technology to insource work and upgrade their newspaper products.

European value added trend Belgium's Roularta Media Group group — a long time user of dryer equipped newspaper presses have recently installed the world's largest double-width newspaper heatset press. Verlagsgruppe Passau, have installed heatset presses at two of its sites — one of which is printing part of 'ÖSTERREICH' as a commercial job. Established European users also include Axel Springer in Germany with an advertising magazine supplement using a heatset cover and coldset text to help bring back classified adverts to print from the Internet; and in Finland, Helsingin Sanomat produce a real estate newspaper insert with adverts adapted to Internet style and connected to their Internet site.

North American diversification and flexibility Newspaper Next is an initiative from American Press Institute to research and test new business models for the newspaper industry. The 2008 report 'Making the Leap Beyond Newspaper Companies' includes case studies of 24 new products from publishers — the majority of which are based on value added concepts (see www.newspapernext.org). Outsourcing of daily and weekly publications is a trend for some publishers, while many small newspaper printers have added hot air and UV curing units to extend their product flexibility.

APN Australia — World's first 2 + 1 hybrid press

APN News & Media is a major newspaper publisher in Australia and New Zealand with 23 daily and over 100 non-daily newspapers for regional and rural areas. Their new Yandina printing site in Queensland produces more than 50 titles per week including daily, weekly and bi-weekly newspapers as well as external publications. The flagship title — the 'Sunshine Coast Daily' — services one of the fastest growing regions in Australia.

The new site replaced two older plants with the objective to optimise costs, improve product flexibility and quality, and to insource magazines and supplements produced by commercial heatset printers. The innovative technical solution developed with manroland led to the world's first installation of a combined coldset double-width and heatset single-width press line. Four REGIOMAN double-width printing towers are linked with a single-width UNISSET 75 tower that delivers heatset printed webs into a common folder. This combination can produce heatset ROP 4-page covers or 8-page sections on coated papers that are combined with standard 45gsm newsprint from the coldset line. The installation has two folders (with tabloid stitching) to enable separate coldset and heatset printing.

A proportion of the heatset print run was initially printed externally to assess the internal production quality. According to Greg Carson, general manager for APN Print at Yandina, the quality of the internal heatset production was as good if not better than the external product. *"The heatset capability is ideal for the region's markets. Previously we outsourced heatset production that often made it cost prohibitive, but now we have our own capability our sales and marketing teams have a competitive advantage and a point of difference in the market."*

Transcontinental, North America — Outsource and Value Added

Transcontinental is the sixth biggest North American printer. The Canadian company is the country's largest printer and a leading publisher of consumer magazines and community newspapers. Transcontinental have also developed unique strategic partnerships for newspaper printing outsourcing and value added services. Their Transmag newspaper printing plant in Montreal — that produces daily and weekly newspapers and specialty publications — will become one of the most modern in the world in 2009 when a new investment programme is completed. This includes a triple-width COLORMAN press with eight 4-colour satellite towers equipped with the continent's first Inert UV curing system from Eltex to allow printing on a wide range of paper grades. Transcontinental clients will benefit from the availability of 100% 4-colour on every page with improved product quality and efficiencies, produced within tighter deadlines. *"This \$60 million investment is part of our strategy to become North America's leader in newspaper printing outsourcing,"* said François Olivier, President and Chief Executive Officer, Transcontinental.



The photograph shows the UNISSET heatset web leaving the MEGTEC dryer (in the background to the right). The web is then split into two, and one half becomes the newspaper's 4-page cover that is merged with the coldset double-width web in the REGIOMAN folder superstructure (foreground). Photo: DIC Australia.

How effective are inserts?

According to the German ZMG study, consumers pay about 27% more attention to advertising material inserted in a newspaper compared with those delivered by other methods. Generally inserts get more attention and have a longer average lifecycle in the home than the newspaper itself. Research in the US on consumer preferences found that 63% of respondents prefer preprint insert delivery against 25% who preferred direct mail and 65% prefer inserts on coated paper compared to 16% on newsprint



“ÖSTERREICH” is an integrated media package of a daily newspaper with magazines, combined with a 24-hour Internet presence. Photo: manroland.

‘ÖSTERREICH’, Austria — media innovation

A completely new type of paid daily newspaper was created by Wolfgang Fellner in Vienna in 2006. It is targeted to readers from the urban e-generation and to upmarket advertisers. The newspaper offers them an integrated media package of a daily newspaper and magazines, combined with a 24-hour Internet presence. The weekday circulation of 300 000 copies doubles on Sunday to over 600 000. The structure of the newspaper and the combination of printing process and papers is unique in Europe.

“In view of the Internet boom I want to see the daily paper flourishing again as a medium. The daily paper will become a topical magazine. The role that daily papers used to play is being taken over by the Internet.” — Publisher Wolfgang Fellner.

The daily newspaper consists of a 32-page national section and a 16-page regional section (with five editions) printed coldset, combined with two stitched and trimmed 24-page heatset magazines on coated paper. The publication blends the style, appeal and quality of a magazine with the topicality of a daily paper in a tabloid format. In addition, every Friday “Österreich” readers receive a 48-page TV insert, and on Sundays the newspaper is wrapped by a 32-page heatset cover.

Wolfgang Fellner wanted to offer high printed quality up-to-date — something that classical insert techniques could not offer. The production solution was to outsource printing to two companies operating combined heatset-coldset double-width presses at Fellner Media AG near Vienna, and at Passauer Neue Presse in Germany.

Herold Druck , Austria— technology innovation

Herold Druck und Verlag AG prints the world’s oldest daily newspaper ‘Wiener Zeitung’ alongside the largest free newspaper in Austria ‘Die Presse’ and ‘Heute’. Production is around 5 million newspapers weekly including commercial production of other titles and catalogues. The company identified three main issues for its development: 1, Expand printing capacity for its daily newspapers; 2, Print differentiated products; 3, Increase product flexibility to utilise the non-productive day shift to print products outsourced to commercial heatset printers with shorter lead times.

The 2005 investment decision was to add a fourth tower to the existing COLORMAN along with a dryer to allow printing on coated paper. The physical constraints of the building ruled out a heatset dryer but at that time the compact Eltex INNOCURE Inert UV system became available. The first UV printed copies were produced in early 2007 at the full press speed of 11,25 m/s — the previous fastest Conventional UV web offset production speed was 7 m/s.

Herold’s new production system generates significant cost savings because supplements can either be printed ROP or assembled by their publishing systems. One example is that many free newspapers cannot have loose inserts because of litter regulations. These are now converted to an ROP cover printed UV on coated paper that is printed simultaneously with the coldset section and stitched in-line. *“We are very satisfied with the investment, and we are now considering a second press line with two Inert UV curing units,”* comments Thomas Unterberger, Chief Technical Officer, Herold Druck und Verlag AG, Vienna/Austria.

Roularta Media Group (RMG), Belgium — multi-media and international

RMG is Belgium’s largest media group with over 3 000 employees. They publish daily and weekend newspapers, magazines and advertising inserts and have extensive audio visual interests. The company began publishing with the weekly provincial paper ‘Krant van West-Vlaanderen’ with local editions that today has a circulation of 400 000. RMG subsequently launched a national network of free local papers that now has more than 50 editions totalling 2,7 million copies weekly. In the last decade RMG have launched many free papers, magazines, and new TV channels. Growth in publishing is based on innovation — one example is a unique free Sunday newspaper ‘Zondag’ of 500 000 copies with 14 editions distributed through bakers’ shops; another is free city magazines with interactive web sites to complement the printed editions. Media activities have been extended to neighbouring countries with magazines, newspapers, and the purchase of the French media group Express-Expansion.



Thomas Unterberger, Chief Technical Officer, Herold Druck und Verlag AG, Vienna/Austria handling a lamp module of the Eltex INNOCURE Inert UV dryer installed on a press extension.



Roularta in Belgium recently installed the world's largest double-width newspaper heatset press — four COLORMAN towers each equipped with MEGTEC dryers to print up to 128 tabloid pages. Photo manroland.

RMG have been using newspaper presses with dryers for over 25 years. In 2007 they expanded their capacity with the world's largest double-width newspaper heatset press — four COLORMAN towers each equipped with MEGTEC dryers to print up to 128 tabloid pages. In addition, two classic commercial heatset presses of 72-page and 16-page A4 formats have also been installed. Part of the additional press capacity will be used to insource production of publications from commercial printers.

"The market requires 4-colour in highest quality – that is why we invested in the COLORMAN with dryers to allow printing on coated papers," comments William Metsu, Director General of Printing Operations at Roularta. *"Customers pay for better quality". As an example he cites the Steps city magazine printed on the newspaper press. "When advertising customers for such a lifestyle magazine look at it they see it is well printed on good paper and they are prepared to pay a bit more."*

Heatset is used for all the colour pages of the 45 regional Streekkrant weeklies and the result, according to Metsu, is that, "they visibly stand out from the competition and this helps sales". One further observation makes him optimistic as scarcely a single customer opts to move its advertisement back to poorer paper and a single colour. (Deutscher Drucker No.3/1.2, 2007).

Verlagsgruppe Passau, Germany — technology investment

The group is now one of the largest publishers and printers of regional newspapers in Europe with operations in Germany, the Czech Republic, Austria, Poland and Slovakia serving 6 million readers. The group's 4 500 employees work in five countries at 17 plants producing 3,3 million copies per day. In 2005, Verlagsgruppe Passau initiated an investment programme to position themselves for the trend towards differentiation and added value production of newspaper and related publishing opportunities. Two of its 17 printing sites have now installed heatset equipped COLORMAN presses — at the home site of Passau and also in their new printing centre at Katowice, Poland. These presses allow the creation of new printed products for the high-quality publishing segment. In Passau, the daily 'Passauer Neue Presse' has 15 regional editions and a total circulation of 180 000 copies, alongside many other own publishing products in both broadsheet and tabloid formats. One of its first new heatset-coldset customers was the part printing of the new Austrian daily 'Österreich'.

Comparative Value Assessment



Seven editions of the same newspaper were printed on four different paper grades by different print processes and assessed by an international industry panel to rank quality and advertising premiums.

Increased colour gamut increases revenue potential. A key part of the VAPoN project has been to initiate an industry discussion on the value of differentiated newspaper products. Improved quality must be related to what revenue or competitive advantage can be generated from them to build a business case for their deployment.

To assist this inquiry, a series of seven editions of the same newspaper were printed on different papers by different print processes. An international survey of the perceived quality and value was made to identify if there is a relationship between paper-print quality and revenue. The responses were independently collated and analysed by Swansea University. Assessments were made by 77 newspaper staff from around the world with responsibilities in production, advertising or publishing. Over 90% of the respondents work for daily newspapers, of which 60% also produce supplements. The print samples were visually assessed by the respondents, who ranked the samples in the order of perceived quality and then assessed the percentage advertising premium that could be expected from each (standard newsprint printed with coldset inks was the base 100% reference point).

Quality ranking

The 54 gsm LWC and 52 gsm SC-B papers printed heatset achieved the highest results. A similar trend was found for printers and the publishers when the results were broken down by professional responsibility, whilst advertising staff ranked the 48 gsm matt C printed coldset second highest and almost as high as LWC printed heatset.

Value premium

Respondents then estimated the percentage sales premium for ROP advertising for each paper-process combination. The average premium over standard newsprint was 34% for LWC and 24% for SC-B printed heatset, whilst the coldset 48 gsm Matt was rated at 20%. This premium range is similar to the previous value added step to 4-colour advertising that attracted a 31-37% revenue premium over 1-colour ('Advertising Science', WAN 2006).

Print characterisation

The physical characteristics of the samples were then measured and analysed at Swansea University to identify if there are any physical correlations with the results of the surveyed "naked eye" perceptions. Among their findings are:

Paper whiteness: The whiteness of the papers alone does not directly correlate with the ranking of the visual assessment. SC-B, ranked second best, is only as white as improved newsprint. LWC has higher whiteness and was ranked best, but matt VAC with highest whiteness only ranked third. This suggests that opacity and show-through was not perceived as a major print quality issue.

Gloss: The two best performing samples have a far higher substrate gloss than the other papers. However, there is no clear correlation when ink gloss is considered. The two highest ranked printed samples have high ink gloss, whilst the two lowest ranked have the next highest ink gloss.

Chroma: The chroma of the printed inks was measured with a spectrophotometer in selected solid areas of flat tone where there was no colour printed on the reverse side (to prevent the results being influenced by show-through). All the patches show a correlation for higher chroma with the highest ranked print samples.

Gamut: Selected images were scanned and analysed using special software to plot the colour gamut for each sample. This represents the location in a^{*}b^{*} colour space of each pixel in the image. The order of the data means that the points created by the highest ranked print are overlaid with those from the next ranked print, so an increase in gamut can be seen. The rank obtained from the visual assessment corresponds with the progressive enlarging of the printed gamut.

There is a direct correlation between the chroma of added value paper-print products and the assessed additional revenue that these products could attract. The economic evaluation of additional printing costs for heatset and coldset shows that the production cost increase is lower than the higher advertising revenues, indicating that there is a positive ROI (Return on Investment).

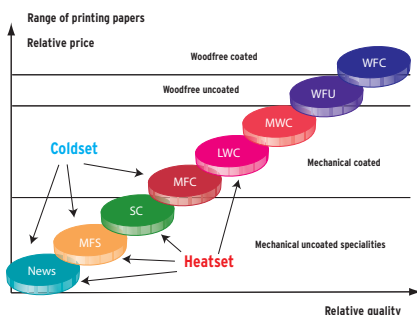

Paper and processes used in VAPoN test printing number one.

Definitions: Chroma is the purity of a single colour; Gamut is sum of all colours available from four printed colours.

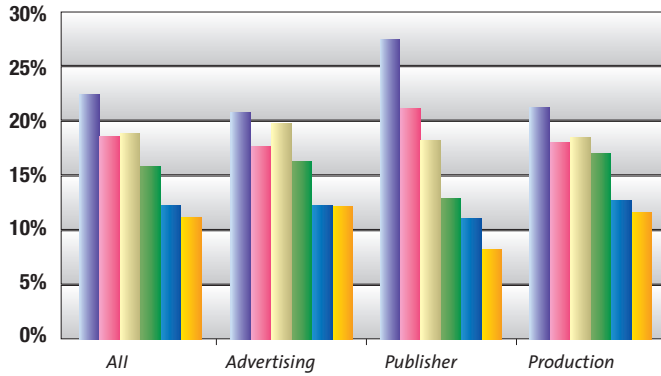

Ranked paper type

- 54 gsm LWC printed Heatset
- 52 gsm SC-B ISO 67 printed Heatset
- 48 gsm Matt C (VAC) ISO 80 printed Coldset
- 48,8 gsm Improved Newsprint ISO 72 printed Heatset
- 45 gsm Standard Newsprint ISO 58 printed Heatset
- 48,8 gsm Improved Newsprint ISO 72 printed Coldset

The visual assessment of paper-print samples to rank them in a quality order was basically similar for all professional groups except advertising staff who ranked the 52 gsm matt C printed coldset second to LWC printed heatset.

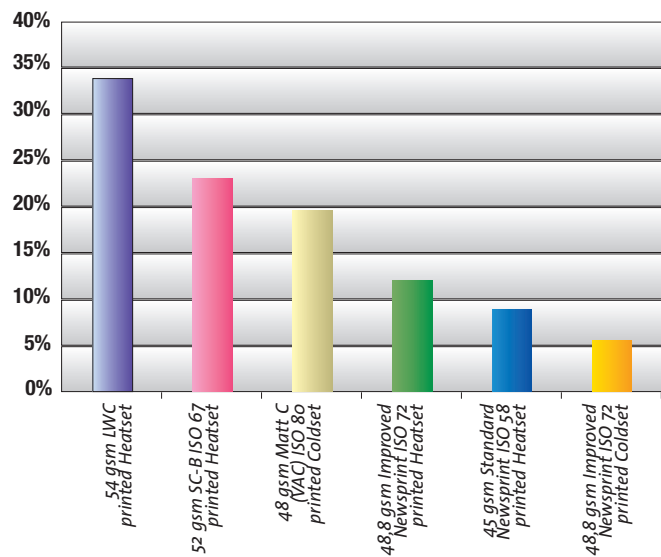

Sales premium

Respondents' assessment of the estimated percentage sales premium over coldset for ROP advertising for each paper-process combination.

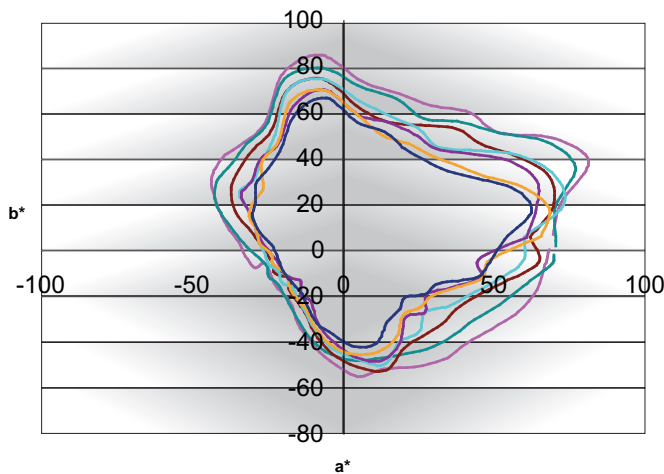

Gamut & premium

- 54 gsm LWC printed Heatset
- 52 gsm SC-B ISO 67 printed Heatset
- 48 gsm Matt C (VAC) ISO 80 printed Coldset
- 48,8 gsm Improved Newsprint ISO 72 printed Heatset
- 45 gsm Standard Newsprint ISO 58 printed Heatset
- 48,8 gsm Improved Newsprint ISO 72 printed Coldset
- 45 gsm Standard Newsprint ISO 58 printed Coldset

The assessed additional revenue percentage plotted against the 4-colour chroma of each sample. The correlation coefficients for the linear fit to the data are over 0.9, which indicates a strong relationship between them.

New Revenue Opportunities

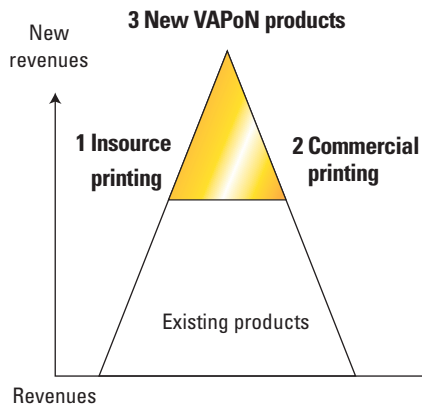

The VAPoN golden triangle for new revenue sources. Source PrintCity.

There are three potential sources of new revenues that all use the same upgraded production system to allow printing on higher grade papers, often combined with alternate formats and postpress enhancement. Ideally, a business strategy should integrate these additional revenues opportunities to determine the optimum market and technical solution required.

1- Insourcing

The opposite strategy to outsourcing. Newspapers upgrade their printing plants to bring some or all of their work in-house that is currently produced externally. US newspapers purchased \$2.4 billion of print work from commercial suppliers in 2004 (US Department of Commerce census). Insourcing offers scope for cost reductions in paper, printing and logistics with shorter deadlines.

Key factors for success: Good production management and quality control.

Financial viability is Cost v Cost:

$$\text{In-house production cost} - \text{external cost} = \text{Margin?}$$

2- Commercial printing

Many newspapers have successfully entered the commercial printing market by targeting low-mid quality advertising and publications. A market evaluation can establish what opportunities exist; this should include combined printing-distribution opportunities that are differentiated against commercial printers.

Key factors for success: Sales and marketing dedicated to the market; adapted production management and quality control.

Financial viability is Cost v Selling price?

$$\text{Selling price} - \text{In-house production cost} = \text{Margin?}$$

3- New VAPoN products

According to WAN research, there is a direct link between the perceived quality of a newspaper and its cover price flexibility. Quality is a combination of content, design, structure, physical format and reproduction quality — the higher the value of these attributes, the higher the cover price limit without loss of readership and/or the potential to increase readership. There is a similar correlation with advertising rates and volume, plus the added effect of circulation on this revenue stream.

Advertising premiums

VAPoN can create new newspaper products and revitalise existing ones that better respond to the changing media dynamic by competing more effectively for revenue share from advertising inserts, magazine and Internet advertising. The VAPoN survey shows that the assessed advertising premium related to higher paper and print quality is in the range of 20-40%. Experience from the introduction of 4-colour advertising supports this — a 31-37% revenue premium over 1-colour. The total media expenditure in a given market place is the pool from which to proactively identify new revenue opportunities.

Convert other publishers' magazine advertising to ROP

Advertising in general magazines can be a source of additional advertising if the newspaper can provide a better value offer (the daily magazine). This could be ROP on high quality paper quality combined with more flexible newspaper timing, better reach and/or some other differentiation. This is in addition to existing newspaper magazines.

Conversion of catalogues and inserts to ROP and/or supplements

Preprinted advertising inserts revenue of US daily and Sunday newspapers outstripped ROP advertising in 2001 and average annual growth has been around 10-12% compared to 0-2% for ROP. A major problem for publishers is that they generally only retain 40-60% of insert revenue because most are printed externally. Inserts and/or mass letterbox catalogue markets represent a huge pool of potential ROP revenue for newspapers that provide the right value proposition.

The nature of advertising catalogues and inserts has been determined by some factors that can be challenged. Catalogues, publication inserts, or letterbox drops are significantly influenced by their high distribution cost that tends to increase pagination and limit frequency. Until recently newspapers were unable to provide sufficiently high quality of paper and printing. These factors can be challenged by VAPoN techniques to convert some catalogue revenue to ROP and/or supplement advertising.

- The potential quality gap is now minor, and ROP newspaper advertising of 2, 4 or 8 pages requires no inserting or added distribution costs.
- This strategy could be of interest to advertisers to convert a single monthly catalogue into multiple weekly ROP pages to generate more continuous promotions.
- This concept overcomes the increasing number of consumers who refuse “junk mail” from which generally free and paid for newspapers are exempt.
- Newspaper distribution is normally completed more rapidly than letterbox drops to provide retailers with just-in-time advertising that can allow late content-price changes 12 hours prior to printing and distribution within 24 hours. This service should provide an additional premium.
- Match the paper’s format, print process and paper grade to the socio-economic market profile of the area in which they are distributed. For example, large Australian cities have one or two free weekly newspapers delivered to all households in 20-40 city communities. The lower economic profiles receive coldset on newsprint, median areas hybrid heatset-coldset and the highest economic targets have complete heatset production on coated paper.

An analysis of all advertising catalogues and their distribution methods should allow target marketing of selected advertisers with adapted media vehicles related to their businesses. This should include using special sections such as fashion, household, motoring or sports sections or supplements.

Key factors for success: Entrepreneurial business strategy, sales & marketing; adapted production management and quality control.

Financial viability of new VAPoN Publishing Products?

$$\text{Extra advertising revenue/cover price increase} - \text{extra production costs} = \text{Margin?}$$

Increased revenue v. Increased costs

Increase in advertising revenue

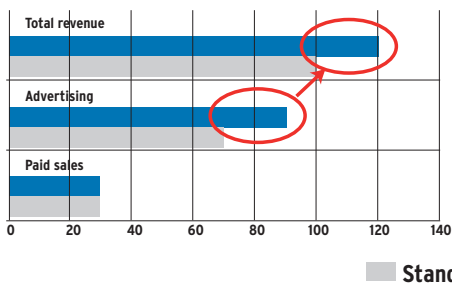

Increase in production costs

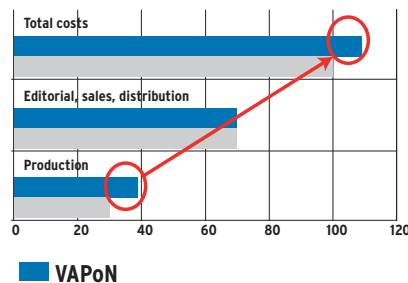

The financial viability of a new publishing product is the difference between increased revenue less increased production costs. This example shows that a 30% increase in advertising revenue increases overall revenue by 21% (left chart). The right chart shows that a 30% increase in production costs increases total publishing costs by only 9% — the result is a 12% increase in margin.

VAPoN Printing dimensions



There is no single technology solution for all newspaper printing applications.

Heatset, Ultra Violet (UV) and Electron Beam (EB) are all mature ink drying technologies used by different segments of the printing and packaging industry. Until recently, only coldset and heatset have been widely used in newspaper applications but recently UV has been installed on some newspaper presses. Digital has established itself as a production system for very short newspaper print runs using both toner and inkjet technologies. Another application is to integrate inkjet into conventional coldset presses to allow variable copy-to-copy image changes without stopping the press.

Paper-ink-drying systems

Printing qualities are determined by the interaction of three critical elements — the paper grade, the ink technology and its drying-curing system. These three elements also determine whether coated paper can be printed; and strongly determine total production costs. Sustained production speed is a key criterion for most newspaper operations and the paper-ink-drying combination also determines the maximum production speed available from a given process technology.

Paper

The biggest “lift” in perceived quality comes from the choice of paper — it is the single most important element that defines quality. The levels of brightness and print gloss strongly influence the value attached to each grade. The ink drying system used determines the range of paper grades that can be printed and only heatset or radiation ink-drying (UV/EB) can print on all grades of paper.

Options for coldset production include Improved Newsprint with higher brightness. UPM Matt C is the only mechanical coated grade designed for high quality coldset 4-colour printing. It has the optical and surface enhancements of a coated grade and the absorption and performance characteristics of a normal coldset paper, this special type of paper is also called Value Added Coldset (VAC).

Ink consumption

Ink densities on SC/LWC papers tend to be higher than coldset on newsprint; however, higher grade papers tend to consume less ink, e.g. UPM indicates that coldset MFC should use 15-20% less ink than standard newsprint. Standard Ink Densities (SIDs) for coldset on newsprint are a compromise between visual appearance and adverse effects such as marking, rub-off, set-off and print-through. The visual effect of density is logarithmic, which means there is a rapidly diminishing increase of density compared to the increase of ink weight on paper. However, the adverse properties of ink weight on paper tend to be linear. Different papers have different levels of maximum SID, and the differences are present even within a single grade because of differences in fibre composition and surface properties — for example coldset ink consumption on newsprint can vary over 20% between paper suppliers. Therefore, be very cautious about the impact on ink consumption when changing paper grades, suppliers and processes.

Ink consumption is a function of image coverage on the plate and ink film thickness. Consumption can be minimised by up to 25% through optimisation of prepress, use of finer screens, densitometers or closed loop colour control. A fundamental for success is to have plate compensation curves for each process and paper grade. The European Colour Initiative is developing ISO-based ICC profiles specifically for heatset paper grades because those for the current ISO 12647-2 are for sheetfed. In addition, This Ifra's has recently been developing recommendations for standard of heatset printing on newspaper presses.

Each paper grade has an optimum ink density and any increase in ink beyond this has a decreasing impact on density.
Source: “Changing Paper Grades”
WOCG/Sun Chemical.

- SC 55 gsm
- INP 55 gsm
- NP 49 gsm
- LWC 80 gsm

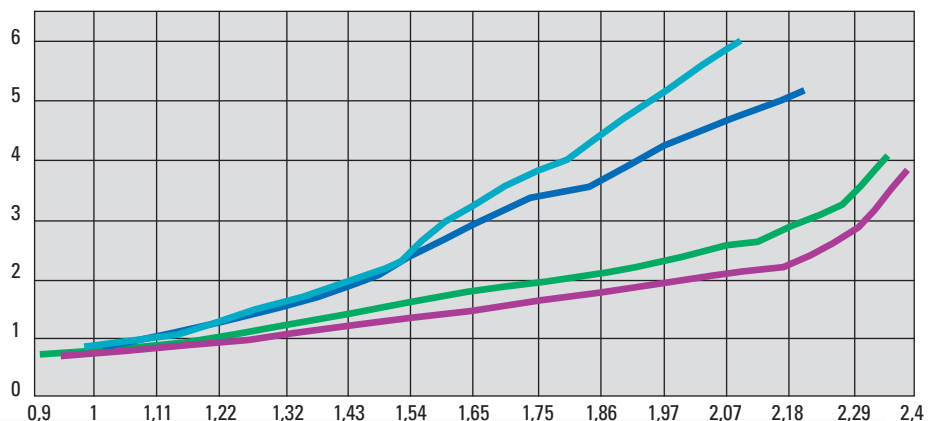

Printing process comparison

The second VAPoN News test printing compares coldset, heatset and Inert UV production on four paper grades. Herold Druck in Austria printed the UV versions, while Passauer Neue Presse Druck in Germany printed the heatset and coldset.

Paper and Ink gloss

Trial	Ink	Paper	Gloss at 60			
			Paper	Yellow	Cyan	Magenta
L	Heatset	UPM Cote H 54 gsm LWC	22,5	22,1	17,2	19,5
I	Heatset	UPM Cote H 49 gsm SC-B	6,6	15,0	10,9	13,9
Y	UV	UPM Cote H 54 gsm LWC	22,5	16,0	13,2	11,6
W	UV	UPM Cote H 49 gsm SC-B	6,6	10,7	8,9	8,6
C	Heatset	UPM News C 48,8 gsm News	4,1	3,8	2,8	3,0
N	Coldset	UPM Brite 72 C 48,8 gsm INP	4,1	4,7	3,1	3,6

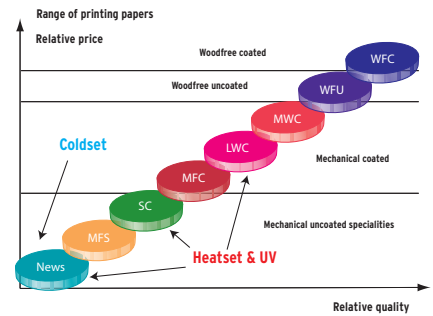

Paper and processes used in VAPoN test printing number two.

UPM Cote H (LWC) and UPM Eco H (SC-B) are both super calendered papers developed specifically for heatset printing. LWC is a coated paper, and has far higher gloss than the other papers. Heatset printing on LWC (trial L) resulted in ink gloss levels similar or slightly below the coated paper, whereas printing with UV lowered the gloss level (trial Y). The gloss of the heatset and UV inks was higher than the SC-B paper with lower gloss. The UV ink had a slightly lower gloss level than heatset. However, heatset ink densities were higher than those of all other trials. Therefore, it may be unfair to assume the gloss of UV is inferior to that of heatset. The results also suggest the surface treatment of the paper contributes to the gloss levels.

Ink density

During the trials the densities were adjusted to ensure reproduction of the full range of low key and high density images. This infers that coldset was losing low key area. The two heatset trials produced the largest gamut and coldset the smallest. The difference between the UV and heatset gamuts can be attributed to the amount of ink being laid down. However, a direct comparison can be made between the coldset and the UV as the solids are similar density.

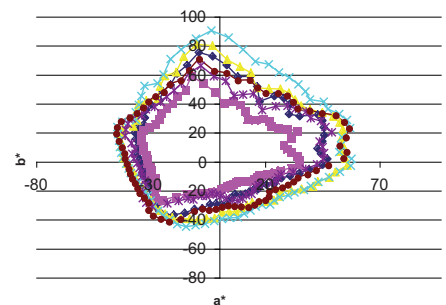

Tonal range

The plot of L* against occurrence is a measure of the printing ability to reproduce the images with different tonal ranges. The coldset on improved newsprint has the smallest range, while heatset on newsprint has only a slightly larger range. This is particularly at the low L* values, with maximum print density. The high L* values reflect the effect of the whiteness of the paper. Heatset and UV achieve similar high ink density levels (lowest L* values).

The tone values were also calculated from IT8 printed targets. This shows that heatset on 54gsm LWC transfers the least amount of ink in the halftones compared to all other trials.

The influence of the paper can be seen from the two heatset trials. When printed on to another paper developed for heatset, the tone value levels are only slightly higher (10% in the shadow region). However, when printed on to INP, the heatset has the maximum tone difference, whilst coldset has relatively low tone difference. UV produces similar results on both papers. These results show there is a strong interaction between the paper surface treatment and the quality of printing.

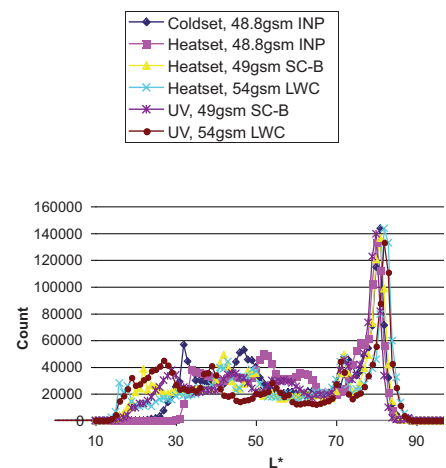

Oil-based ink systems

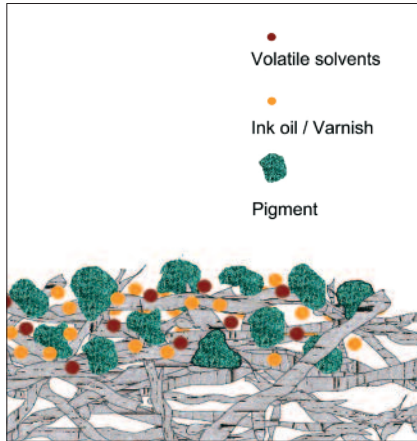

Conventional coldset ink

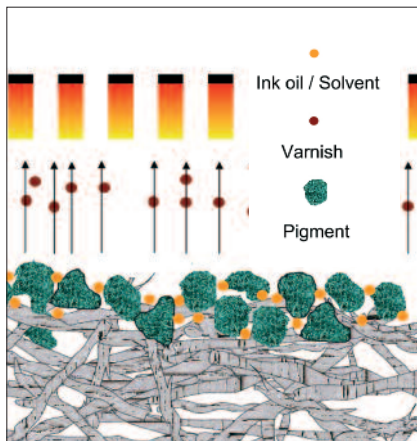

Conventional heatset ink

Oil-based coldset and heatset ink drying systems provide the most reliable high speed performance today. These vegetable or mineral oil-based inks have a long molecular structure, pump easily and have low misting.

Overprint Coldset Coating: The application of a very thin film of overprint coating to the wet printed copy is currently being developed to address coldset issues of set-off, marking and rub-off. These problems are dependent on many variables but the most important is the amount of ink on the paper (both optical density and total ink coverage). Printing on a coated paper makes these problems much worse. The new Sunshield system from Sun Chemical (patent applications pending) provides answers to these issues. Tests show that the coating film does not impede the normal setting of coldset ink, and protects the printed copy during its passage through the press, folder, delivery and postpress operations. In addition, it is possible to satisfactorily print standard coldset ink on relatively non-absorbent substrates such as LWC as well as newsprint. The new coating system also has minimum print-through, which may be the delimiting factor for ink film weights.

Infrared – IR: The “hot topic” of the mid-1990s that went cold very quickly. In practice IR only marginally improves coldset ink penetration to reduce smearing and set-off and has poor performance on coated paper even with very slow printing speeds. IR works most effectively with black and blue inks that absorb IR wavelengths but are very poor with lighter colours like magenta and yellow, which are the most critical 4-colour process inks. With viscous inks IR does help printing by warming the inks to give better penetration. Some users produce smear-free cover sections on newsprint or SC paper at 7m/s using modified heatset inks.

Heatset: Hot air drying is the most commonly used value added newspaper process because of its flexibility to print on all paper grades with improved ink gloss, minimum TVI and marking. Heatset is a mature, reliable and easy to operate process that is cost efficient and has been used on newspaper presses since the late 1960s. Heatset provides unrestricted drying on all web offset paper grades at up to 18 m/s and has the lowest total production cost compared to all other value added technologies.

Recycling of printed products

Recycled paper is often the only raw fibre material used by many paper mills to make 100% of newsprint, and/or is mixed with wood-containing SC and LWC papers. Changes in the quality of recycled fibre could occur from changes to the printing process in a given geographic area. The key issue is the separation of the ink from the fibres. Heatset and coldset offset have no problems in this respect. However, Flexo and UV cured printing raise the questions of whether the currently available papers are suitable for these processes and their subsequent recycling. Sheetfed UV printing and coating represents only a small proportion of printed products in the waste paper supply today, and newspaper UV printing is still at an early stage — both currently have low impact. However, the adoption of UV by a high volume newspaper could significantly impact the mix of recycled paper to a mill in a given area. For this reason, paper and ink suppliers have started to investigate the impact of a large increase of UV products in the used paper stream and its effect on the purity and quality of the recycled fibre.

Radiation curing inks

All radiation inks allow printing on any substrate, without marking and little heat transfer to the paper. The ink formulations are lithographically robust but have significant issues related to their low molecular weight ink chemistry. The largest challenge is ink slinging and misting that limits speed and also can cause web breaks.

These systems are based on acrylate chemistry and have short molecular chains — rather than the long molecular chains of oil-based coldset and heatset inks. Unfortunately, acrylates are a high cost ingredient in limited supply, which helps explain why they are 300-500% more expensive than oil-based inks and are unlikely to reduce in cost. Inks are cured (rather than dried) using three different systems to initiate chemical bonding:

Conventional UV: Inks contain a photo-initiator that reacts to a specific set of wavelengths and intensity of UV light to almost instantly promote bonding to cure the ink. Current highest production speed is 7 m/sec for a narrow web business forms press, 5 m/s for single-width newspaper and sheetfed presses.

Inert UV: An inert gas eliminates oxygen molecules that inhibit ink curing to allow printing speeds of 10-12 m/s along with other advantages.

Electron Beam: Uses radiation without photo-initiators but requires an inert gas to create an oxygen-free curing environment. Speed should be similar to Inert UV. Today EB is mostly used in packaging.

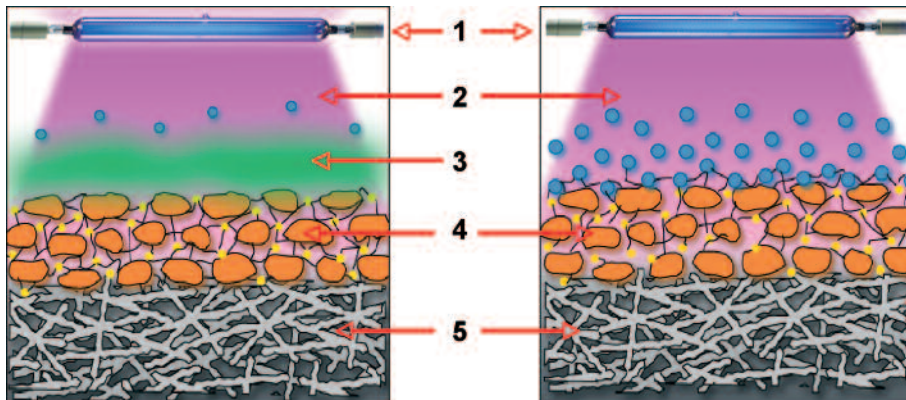

Inert UV

The green layer (3) is the inert nitrogen layer that keeps the oxygen molecules away from the process.

Conventional UV

*1: UV lamp
2: Atmosphere under the lamp
3: Oxygen molecules inhibit curing
4: Ink with photoinitiators
5: Paper substrate
The blue circles are oxygen molecules reacting with free radicals of ink in Conventional UV.*

Newspaper UV systems

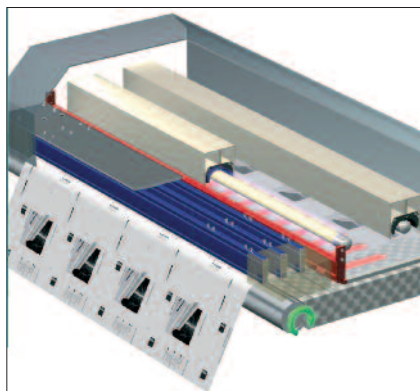

The closed chamber UV concept replaces oxygen with an inert gas. Eltex uses three special charging bars to generate the plasma current to break up the surface-air boundary layer to move oxygen away from the paper/ink surface and replace it with nitrogen. The result is a 35% reduction in power, more gloss and less wasted heat.

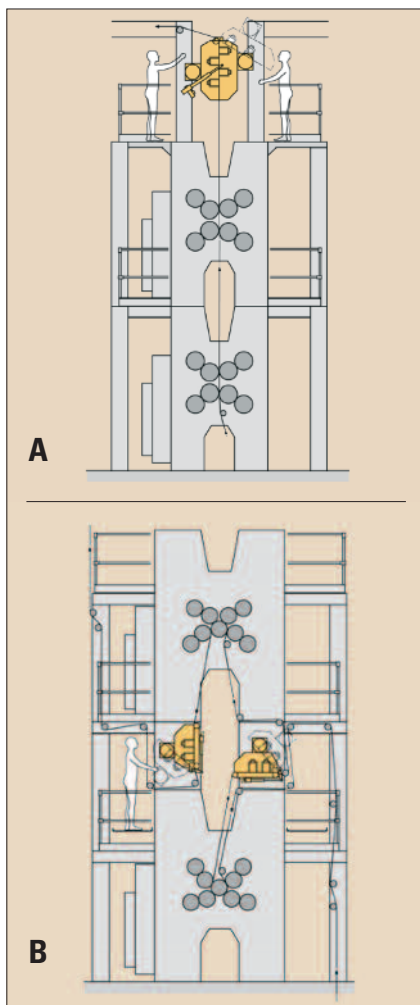

A Blanket-to-blanket press UV installation.
B Satellite press UV installation between the upper and lower satellites. Source manroland.

The big advantage of UV curing is that its compact size allows retrofitting to existing presses that do not have adequate space or foundations to install a hot air dryer. In addition, no air pollution control (oxidizer) or chill rolls are normally required. On the other hand, the costs of consumables — ink, rollers, blankets and washing solutions are higher than those for heatset and coldset. UV lamps are normally replaced after about 1 500 hours of use.

Conventional UV

There is a mini boom for Conventional UV dryers on single-width single-development newspaper presses printing at a maximum speed of up to 5 m/s on mostly coated paper. Conventional UV curing efficiency is inhibited by the oxygen boundary layer close to the paper surface. A snapshot survey of seven US installations shows that average printing speeds range from 3 to 4,5 m/s. Presses running in combination mode print 5-35% UV and the balance conventional ink. All of them print advertising inserts and other commercial work, while newspaper products account for about 20% of output.

Inert UV

Inert UV uses a gas (like nitrogen) to reduce oxygen inhibition. The Eltex INNOCURE innovation applies electronic plasma technology to increase the efficiency of inerting. The result is about a 40% reduction of UV lamp energy consumption that allows high speed printing up to 12 m/s with only two UV lamps per side. A further advantage is that Inert UV does not create corrosive ozone that is a by-product of Conventional UV.

The first Eltex Inert UV system was installed at Herold Druck in Vienna on a retrofit manroland COLORMAN tower. The two satellite units are separated by a structure that houses the UV curing systems (one for each side of the web) with the gallery levels and interfaces adapted to the existing press. The first saleable UV printed copies were produced in February 2007 at the full press speed of 11,25 m/s. Experience shows that the most satisfactory UV colour sequence is to print black last (CMY-K), which is the same as coldset. Printing results improved when the UV inks are around 26°C (rather than 20°C normally run for coldset). The surface temperature of the paper increases by only 12°C after passing through the curing unit which has very low heat radiation — this means low temperature stress to the paper. The main operator input is to set the energy for the curing system — around 60% of installed energy draw is used at the moment. INNOCURE is a complete industrial sub system that can either be mounted between satellite units (as at Herold), or on top of a blanket-to-blanket tower. The system includes a nitrogen tank, a cooling water and circulating system, special UV power supply (ballast) and control system.



Electron Beam (EB)

Currently used for web offset and gravure printing of liquid cartons and plastics. Energy is transferred to the curing process from high power electron beam emitters to generate free flowing electrons that initiate chemical bonding of the inks. This energy is sufficiently high to cure inks on both sides of the paper simultaneously and curing takes place in a compact space at up to 25 m/s. EB requires an inert gas (nitrogen or other) to replace the oxygen that inhibits the curing action — new technologies generate nitrogen more efficiently than in the past. The high electrical energy requires substantial shielding of the machine.

In 1995, an Ifra research project “Improving the print quality with dryers and better paper grades” made extensive tests with an EB dryer at the SID in Leipzig. Its conclusions were that: **“EB curing offers the greatest quality leap because all problems concerning smearing and set-off are solved and full use can be made of higher grades of paper. The feasibility study shows that the installation cost of EB is lower than for a hot air dryer, and that with theoretically higher web speeds EB is given preference over conventional UV curing. Problems are the costs of EB inks, their incompatibility with conventional inks and limited de-inkability”.**

All of these points are still largely valid even if there have been significant changes in all drying technologies. However, the Ifra-SID tests were on a press running at only 2,76 m/s, which did not show up the severe ink slinging and misting problems found at higher speeds that are responsible for limiting production speeds.

EB delivers 10 times the curing energy in comparison to UV (80 v 8 electron volts). High energy and absence of photo-initiators provides more flexibility in ink formulation to overcome slinging and misting, combined with potentially better curing efficiency than UV.

EB is theoretically the optimum newspaper drying process because it offers:

- Smear-free printing on all substrates.
- EB cold cures and the paper is not heated by more than 2-3°C making pre-printing and rereeling a more practical possibility than UV. Rewinding of pre-printed ROP advertising pages was common until the 1980s (using gravure on an upgraded paper) and this approach may be valid for some publishers.
- Constant energy output — no degradation of curing intensity (unlike UV lamps).
- Ink drying is unrelated to colour hue (unlike UV).
- No pre-heating and infinitely variable control to changing press speeds.
- Both sides of the web are cured from a single unit in one side (unlike UV and hot air).
- EB uses less energy than either UV or heatset.
- No ozone is produced.
- Low maintenance with wear related only to cathode wires, window foils and o-rings. (ESI claim hourly spare parts cost of less than 1 Euro per operating hour.)

EB cannot currently alternate production with conventional inks (unlike UV or hot air). The EziCure new generation of low voltage, low cost EB generators from Energy Sciences Incorporated are compact, lighter and suitable for printing applications. Low voltage operation and new window technology optimise energy to the substrate with a highly accurate curing depth.



Compact new low voltage EB generators are theoretically the optimum newspaper drying process if the ink systems can be developed to run fast enough. Photo: Energy Sciences Incorporated

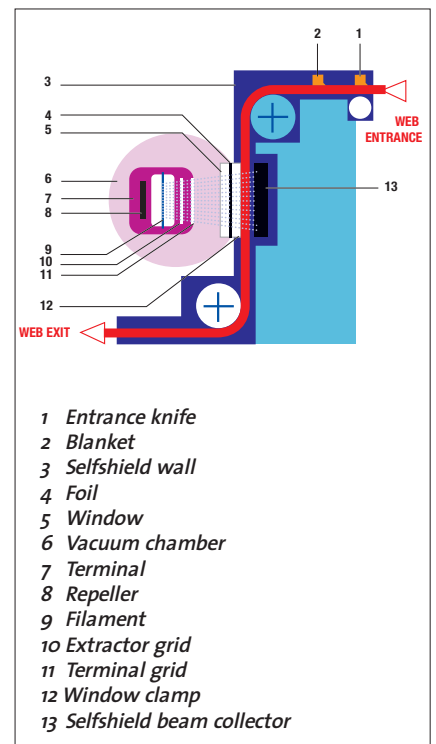

Filaments emit electrons that are accelerated by high voltage to pass through the window foil to strike the ink film on the substrate where the electrons initiate molecular changes to cure the ink. Source: Energy Sciences Incorporated.

Operating issues for UV and EB

	Conventional oil-based 100% of production
Inks	Polar
Blankets & Roller covers	NBR (Polar)
Washing agents	Non-polar
	Combi or alternating Conventional/UV
Inks	Polar — Non-polar
Blankets & Roller covers	HNBR (combi)
Washing agents	Polar — Non-polar
	UV inks 100% of production
Inks	Non-polar
Blankets & Roller covers	EPDM (Non-polar)
Washing agents	Polar

Blankets, rollers and washing agents must be matched to the ink type used — different consumables are required in 100% UV operation to combination UV-conventional inks. Source: PrintCity UV Sheetfed UV Best Practice Guide/Reeves.

About 60 000 UV drying systems are installed worldwide for narrow web flexo and offset, sheetfed, screen printing and coating. These ink systems require some different operating procedures and the use of specific consumable materials, some modification to the press and ancillary systems. These differences are normal for the thousands of printers that are currently using UV and EB, they include:

Dampening: A mild acid solution is recommended to remove ink from the non-image areas of the plate. However, if conventional and UV inks are alternated it is recommended to find a single solution working with both ink types because changing ink fountain solution at each job change is not practical. A key factor for successful printing is running with minimum dampening from startup as the window between scumming and streaking is smaller than with conventional inks.

Inking unit temperature control: The distributor and ink fountain rollers of sheetfed presses are normally cooled to help stabilise the UV ink temperature to prevent scumming.

High ink tack: Increased risk of picking on uncoated papers.

Black and dark colour curing: Absorption of the UV light by the pigment may result in loss of cure, excessive use of photo-initiators, or increase in lamp power (not an EB issue).

Ink delivery systems: UV inks are difficult to pump because they are more thixotropic with less flow than oil based. Excessive pump pressure generates heat and can lead to partial UV curing (“dark curing”) in the pipes. Only positive displacement stainless steel pumps are recommended for radiation ink and the pump should be next to the press. Care must be taken that seals and glands are specified for UV/EB inks and pipes containing copper avoided because they can also initiate the curing process. UV products are not self-lubricating and ink pumps should use Teflon bearings. UV inks do not dry in the print unit but a duct agitator is highly recommended because of their high viscosity.

Ink storage: UV ink is more sensitive than conventional ink and “self curing” can occur if it is exposed to heat, sunlight, fluorescent light, oxidising materials.

Combination production: A fundamental operating issue is whether to run 100% in UV or to alternate between conventional and UV inks (combination production), which is common in sheetfed. Each of these operating modes requires a different set of specific roller coverings, blankets and washing solutions. Combination production requires thorough cleaning (blankets, ink fountain, inking and dampening rollers) at every ink change because any residual solvents from conventional inks and washes will inhibit curing of UV ink. Automatic ink cleaning systems do not work well with UV and hand cleaning is time consuming and increases costs. Because of the high viscosity of UV inks and the possibility of dark curing, twin rail systems do not work efficiently and hand cleaning-out of ducts is required (a more efficient alternative is exchangeable ink ducts). In addition, different washing solutions are required for oil-based and UV inks. This means that an automated washing system can only be used for one ink type and the other hand washed; alternatively a second washing solution delivery system can be fitted. In comparison, heatset to coldset ink changeover is comparatively simple, but EB cannot currently be used in alternating production.

Rollers & Blankets: Roller covers and blanket faces are compound materials that interact with the different chemical substances and fluids they transport. Therefore, they must be compatible with the ink type, coating and cleaning agents used – if not the blankets and rollers will swell causing a rapid decline in quality and will need replacing. Roller coverings, blankets and washes are different for 100% UV printing and combination production. EPDM roller coverings should be used if UV/EB ink is used 100% of the time. HNBR should be used if printing alternates between UV and conventional inks. Caution, there are numerous mixed mode compounds available but they are mostly for sheetfed presses. It is essential to use compounds designed especially for web offset presses to run at high nip passing frequencies, comparable to fast running commercial heatset presses. These compounds are available from Böttcher and do not require a start up period with conventional inks. Current experience indicates more frequent washing and a shorter life for blankets used in UV production.

Wash-up solutions: Must be specifically formulated for the ink, roller compound and blanket covering, otherwise there is a high risk of degradation of the surfaces.

More cleaning: Small quantities of solvents, blanket washes, oil, grease and conventional inks will contaminate UV inks and, therefore, cleaning must be meticulous. UV inks tend to mist and it is essential to clean lamps regularly, otherwise their curing efficiency declines. The printing unit and its surroundings will also require frequent cleaning as spilt UV ink always remains wet and is a safety hazard on walkways.

Tone Value Increase (TVI): UV has a higher increase than conventional inks but this is compensated by a one-off adjustment of plate setter calibration curves.

Plates: Not all plate types can be used with radiation inks — check with the plate supplier. Most UV plates have a run life of around 30 000 copies but this can be easily extended by baking the plates.

UV ozone extraction: There is a legal obligation to remove the low levels of ozone from the workplace. The UV lamps are fitted with extraction systems that must be maintained correctly. Ozone is easy to detect and routine monitoring is recommended. Radiation curing inks contain no VOCs and are not yet subject to environmental air pollution control, although some US cities are beginning to require ozone permits and a catalytic unit may be required to break down the ozone in the future. (EB does not generate ozone).

Other extraction: Ink misting should be avoided or at least minimised since it can affect health, cleanliness and hygiene. High-speed presses should be fitted with mist extraction. Further reductions can be achieved by good press maintenance in roller, plate, and blanket cylinder pressures, press temperature control, effective exhaust and general ventilation. Inerting systems for EB and UV require extraction to avoid gases leaking into the workplace.

UV lamps: Operating output gradually declines over a lifetime that is generally around 1 000 to 1 500 hours. The energy of UV lamps is 60% infrared radiation, 25% UV radiation and about 15% visible light. The lamp surface temperature is around 800°C requiring adequate cooling and extraction of excess heat away from the machine. UV power supply oscillation requires an adequate energy supply. High speeds require significantly higher power consumption and there is a risk of a barring effect from pulsing that may require the use of special lamp driver systems.

Health & Safety: Protective clothing and defined procedures must be used in the workplace. Energy curing products can be handled in a similar way to oil-based and water-based products provided high standards of hygiene and working practices are in place. Care must be taken to avoid unnecessary contact with UV products. Eye irritation can be caused by repeated or prolonged exposure to uncured UV products when handled incorrectly. Always read and follow the supplier's health and safety instructions carefully. UV products are formulated from materials that have properties well understood from detailed scientific studies over many years. There is a minor risk that uncured UV ingredients can cause skin irritation which in extreme cases can cause sensitisation. However, there are several thousand UV systems operating worldwide for many years without any apparent major issues to date. Correct ink handling procedures in the printing plant prevent UV sensitisation or dermatitis from oil-based inks.

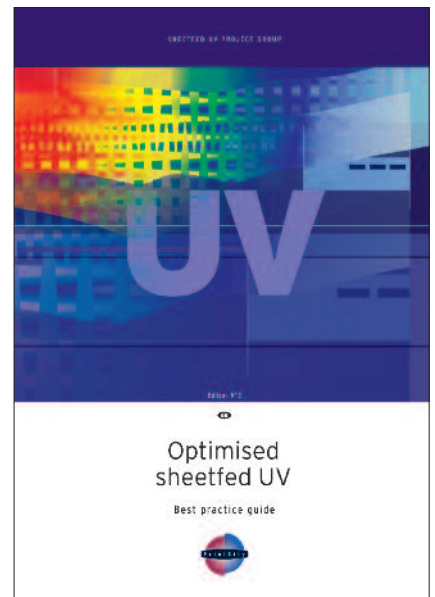

PrintCity's "Optimised Sheetfed UV" is the most complete generic best practice guide available and much of its content is relative to web offset. It is available from project team members Eltosch, Böetcher, manroland, Merck, Trelleborg, Sappi, Sun Chemical and UPM.

Heatset

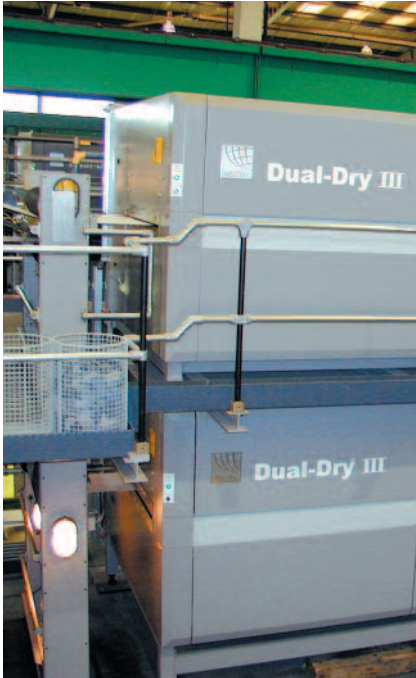

Hot air drying is the most commonly used value added newspaper process because of its flexibility to print on all paper grades with improved ink gloss, low TVI and reduced marking. Heatset has the lowest total production cost compared to all other available added value technologies.

Hot air flotation dryers deliver unrestricted drying at speeds up to 18 m/s and can also be used at low temperature to assist coldset ink drying. A range of oxidation technologies complies with clean air regulations. The integration of an oxidiser into the dryer significantly reduces total energy costs because energy from solvent incineration is recycled back to the dryer.

Heatset is a mature, reliable and easy to operate process that is cost efficient and has been used on newspaper presses since the late 1960s, and is the standard production technology on commercial web offset. Several hundred single-width newspaper presses use hot air dryers and they are now increasingly being used on double-width presses. A partial explanation is the trend to smaller formats with reduced web widths that make many double-width presses only 30% wider than single-width, which simplifies fitting dryers.

A recent innovative press configuration developed by manroland now allows newspaper printers to combine single and double-width presses into a single production system. Heatset webs are run simultaneously on a single-width press directly into the double-width folder that integrates them with the coldset sections. This configuration allows unique advertising and editorial possibilities, including ROP heatset on coated paper for covers, sections and posters. Presses can be installed either as a folder-to-folder inline layout or installed in parallel with a 'bridge' with 90° turner bars to transfer the webs into the double-width folder. Both presses can be run separately and the heatset line can then be used for pre-printing and semi-commercial work.

New heatset user experience

Verlagsgruppe Passau publish their newspapers on coldset presses at 17 sites in Europe. They installed their first heatset press in 2006 and one of its first new jobs was to print part of the new Austrian daily 'ÖSTERREICH'. Karlheinz Dürr, head of production, points out some changes in daily operation. *"In heatset we have to be more meticulous than in coldset with regard to register and to maintain the required ink density. Our experience shows that you cannot rely only on ISO standards for ink density, and you must not, because customers will keep arguing on the basis of their proofs. We are very happy to be commercial printers for 'ÖSTERREICH'. However, we had to see that the potential of the press could be optimised. We had to give up some traditions and train our workforce on the technology. This was quite a challenge for which we had the help of printers experienced in the use of hybrid presses. We were supported by Athesia Druck in Italy, Delo Druck in Slovenia and Helsingin Sanomat in Finland."*

Ink changeover?

Many users simply use heatset all of the time on all products to simplify and optimise production with a single ink type. Switching between heatset and coldset inks is relatively easy and the risk of contamination is low. Ideally inks should be completely purged when changed to prevent any contamination that could effect drying, marking, and tack related properties. However, the commonly used production techniques to minimise downtime and cost at ink changes are:

Heatset To Coldset: A small quantity of heatset ink mixed with coldset on newsprint is normally successful.

1. Purge as much of the ink as possible.
2. Clean blankets thoroughly on changeover to reduce picking and web break risk on newsprint.
3. A high ink take-off helps minimise risks.

Coldset To Heatset: Residual coldset ink can slow the drying of heatset ink, cause marking on coated paper, and TVI issues.

1. Purge as much of the ink as possible.
2. Clean blankets thoroughly on changeover.

Heatset-coldset press configurations

Horizontal heatset dryer mounted on a platform is the most common configuration for high speed single- and double-width presses because there is a wide range of dryer web widths and lengths available with up-to-date technology. A vertical dryer mounted on a chill tower is available for slower speed single-width presses. Although hot air dryers are relatively bulky, practical installation solutions exist for most press environments, including press extensions.

The world's largest heatset double-width newspaper press is installed at Roularta, Belgium. Each of the four COLORMAN 4-high towers is equipped with a horizontal MEGTEC dryer. The press has two quarterfolders to allow separate production of tabloid or broadsheet products. Source manroland.

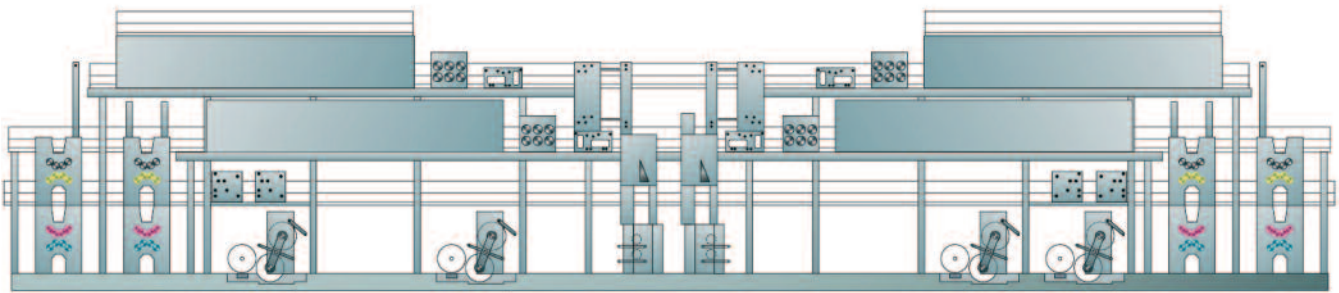

The world's first 2 + 1 press was started up last year at APN News & Media, Maroochydore, Australia. The four double-width REGIOMAN printing towers are linked with a single-width UNISET 75 tower that can deliver heatset printed webs into the central folder. Two folders enable both coldset and heatset lines to be run separately or combined into a single product. Source manroland.

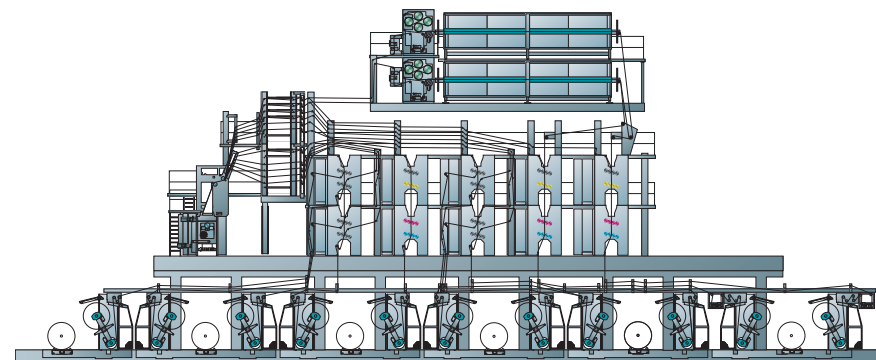
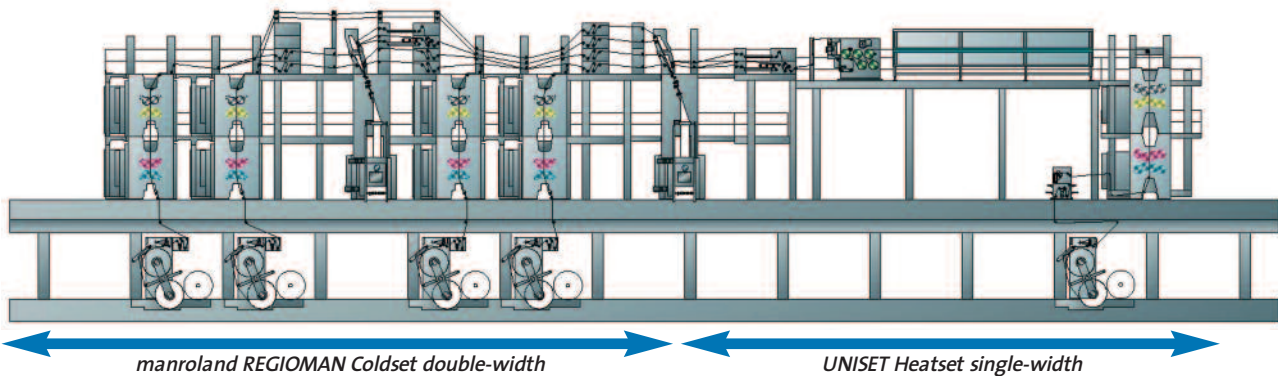

The single-width CROMOMAN installed at Sharjah with 2 stacked MEGTEC heatset dryers. Source manroland.

Digital newspaper printing



Photo Océ.

Decentralised digital printing is now an established alternative for newspaper publishers to provide up-to-date international editions in markets that are too expensive or distant to be serviced by traditional remote site offset printing and air freight delivery.

Océ is the pioneer and recognised leader in short run digital newspaper printing since their introduction of the Digital Newspaper Network (DNN) in 2001. Each day, its presses print over 5 000 international editions of 15 different titles at six commercial print sites – in London, New York, Los Angeles, Sydney, Singapore and Zurich.

“Océ has played an important part in opening up new markets throughout the world for the ‘Financial Times’ and has been an integral part of our development strategy for new printing locations. Producing digital newspapers in colour is another quantum leap forward.”

— Ian Denhard, head of logistics ‘Financial Times’.

Production workflow

Pages for remote digital editions are converted to industry standard PDFs and sent over the Internet, or a direct FTP link, to a central hub. DNN network digital press sites have a direct connection to the hub enabling them to immediately receive and print from the PDFs. Digital newspapers have the same look and feel as those printed by offset using the same format and are printed on newsprint (48 to 52 gsm). Many kinds of newsprint have been tested and certified for the printing systems, including the Financial Times salmon coloured paper. Once printed, the newspaper pages are automatically trimmed and folded, and batched for delivery.

Several technologies can be used for digital newspaper printing in both black and white and full colour. These include dry toner and ink jet systems using either web or sheetfed paper. These presses are often operated by commercial and document printing companies who use them to provide a variety of print products when not running newspapers.

Micro-zone editions

Other applications of digital printing can address the trend to stronger market segmentation where publishers are losing readership and advertising to media that target niche markets more precisely. Many readers want more content that is relevant for their region and personal context. Digital printing allows publishers to create added value products to deliver targeted information that allows them, and their advertisers, to interact with readers more effectively. Another opportunity is specialised targeting - or zoning - of newspapers, and also of individualised newspaper production. This is an area where digital printing can deliver key benefit because they can retrieve data directly from Customer Relationship Management (CRM) systems.

Digital production of short runs is becoming more competitive with offset. Digital printing costs are the same from the first copy onwards because the digital content can be retrieved directly from IT systems and processed without intermediate steps. Publishers should consider all the costs incurred, not just the pure print costs, when considering which method is more efficient. In many cases, a combination of both processes will be the best choice.



Newspaper publishers use digital printing to provide up-to-date international editions in markets that are too expensive or distant to be serviced by traditional methods. Source Océ.

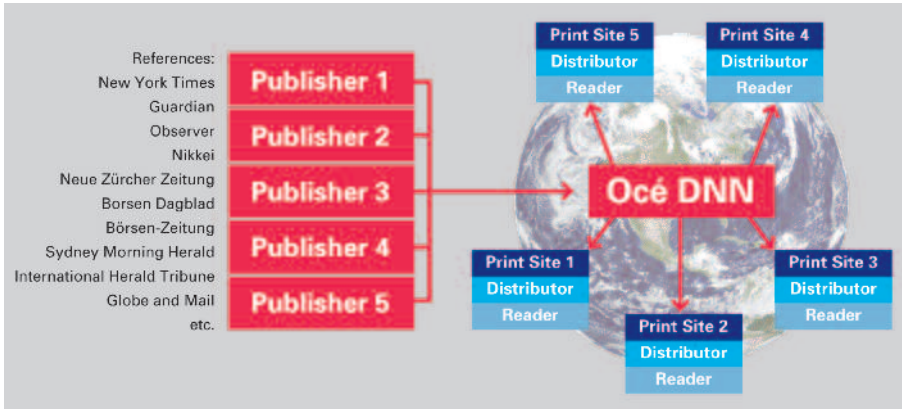

The graphic shows how the Digital Newspaper Network uses the Internet to exchange print files between publishers and remote digital printing sites. Source Océ.

Integrated inkjet for newspaper offset presses

Inkjet digital technology is now available to integrate more fully into conventional offset presses to provide a range of value added functions and, in some circumstances, provide economies in production cost and time.

Integrated inkjet is capable of printing one copy only of each image (image-one-print-one technology), or a very low number of copies. It offers a multitude of applications for imprinting variable images on the cover or inside of a newspaper to support a variety of news, advertising sales and promotional opportunities including:

- Localised advertisements down to the level of one kiosk or street
- Games such as lotteries, bingo, dice or cards
- Numbering and barcodes for different uses including logistics,
- Multi-media printed codes to use with mobile phone cameras,
- Random images, e.g. for test markets.

Integrated inkjet systems allow editions to be updated on the fly and offer one to one marketing capabilities. New systems are capable of printing good quality at 15 m/s on a newspaper press to add text, one and two dimensional barcodes and images.



The web-fed Océ VarioStream 9240 – provides printers with the choice of full colour, spot color and black all in one digital press system. Photo: Océ.

Comparative Economics

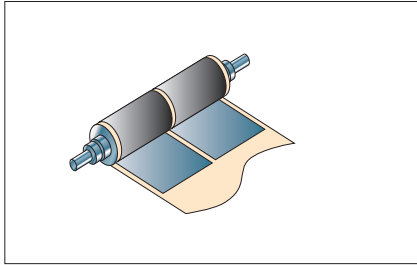

1:1 Single-width single development

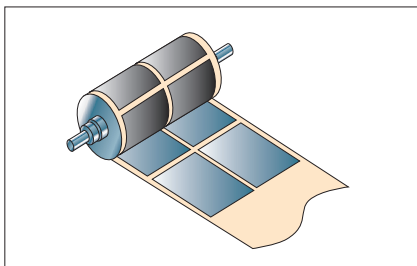

1:2 Single-width double development

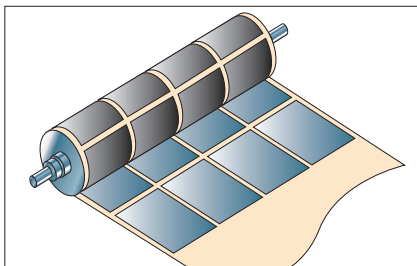

2:2 Double-width double development

The key question when considering alternate technologies is what are their total lifetime economic implications? Too often this information is only partially available and not comparable.

The VAPoN project group made its initial comparative economic assessment in 2006. Since then, there have been some changes in data that have warranted a revised and expanded modelling of all the data. The comparative analysis was made by Eurografica, who have developed comprehensive printing economic modelling for over 15 years. To ensure that the results are both complete and comparative the project team and other experts defined and cross-checked all data and assumptions. The modelling takes a comprehensive commercial approach that shows the interrelated cost implications for investment, annual operating and total printed product costs. These three areas may have different importance to different printing companies. Some newspaper companies may only consider additional direct costs per printed job; others may only partially assign capital costs; while others want to operate as fully accountable profit centres. The web widths and cut-offs of the four presses modelled allow them to produce the same size Half Berliner Format (235 x 315 mm). The cost scenario is the addition of a 4-high 8-couple tower as an extension to an existing press.

1- Capital costs

The total installed investment costs include the printing tower and paster with capacity for coated roll weights. The capital costs of drying and curing systems include installation and all equipment required for each ink-drying process including extraction, oxidation, chill rolls, inert gas, piping, superstructure.

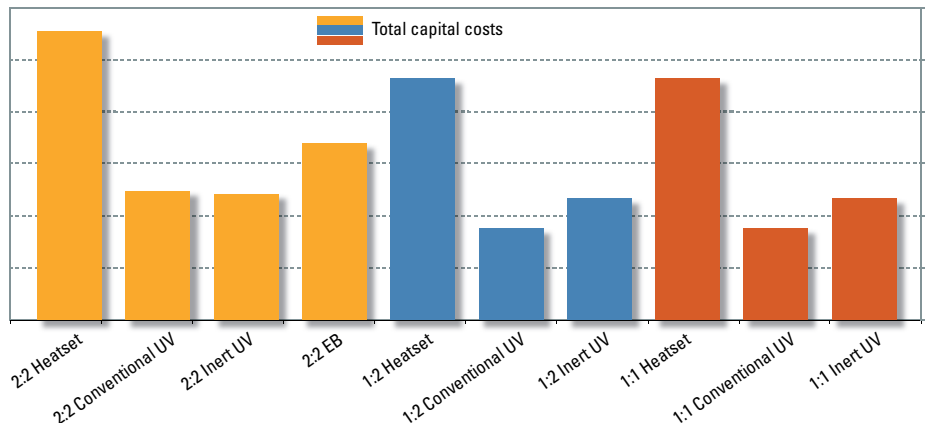

Heatset's installed investment cost is over double that of all other systems. EB (Electron Beam) is the next most expensive. Inert UV and Conventional UV are similar in cost for double-width presses with Conventional UV having the lowest cost for single-width presses.

2- Operating costs

Operating hours are based on three shifts with a yearly total capacity of 5307 hours. Hourly rates include: Labour (1 printer and 1 assistant) at German rates. Indirect production costs include the different consumables for each process such as blankets and rollers; German costs for gas, water and electricity; service and maintenance; and an allowance for administration and sales. Capital costs include depreciation and interest. The costs of factory space are not included as this is highly variable and has no impact on process comparison.

Consumables

UV consumables are generally more expensive than heatset.

UV ink systems: Acrylate chemistry is a high cost factor because its limited supply makes inks 300-500% more expensive than oil-based inks, and the cost is unlikely to reduce. UV inks require photoinitiators to promote bonding but EB does not require them but must use an inerting gas to produce an oxygen-free curing environment (as does Inert UV). There is a claim that UV may use

Heatset	Inert UV	Conventional UV
Integrated hot air dryer-oxidiser	UV lamp system for both sides of web, with closed air cooling and exhaust fan	UV lamp system for both sides of web
Chimney	Closed air cooling installation	Ozone extraction hoods, piping and fan
Support structure	Nitrogen-tank and circulation system	Closed air cooling installation
Chill rolls & cold water supply	Extraction pipes and fans	Electrical Installation
Web guide	Electrical Installation	Installation cost on top of tower
Silicone applicator	Ink agitators on all ducts	Ink agitators on all ducts
Electrical & gas Installation	Low pressure ink supply system	Low pressure ink supply system
95° air bar turning system	Plate baking machine	Plate baking machine

The principal installed capital equipment for each drying or curing system.

less ink than heatset for comparable SIDs, but this has yet to be proved. This claim is based on heatset ink containing about 35% solvent that is evaporated, against UV inks being solids with no volume loss. However, these inks are formulated differently and what is important is how much pigment is left on the paper.

UV roller coverings and blankets: These tend to be more expensive and have a shorter life than conventional materials. Selection of these materials is critical and inks should be tested to ensure the best solution. Different rubber compounds are used (a) for 100% UV production or (b) alternating production between UV and conventional inks. A major issue is to ensure that the right washing solutions are used to avoid risk of damage to the surfaces.

UV lamp life: Lamps normally require replacement after 1 500 hours of use.

Hourly rates

Two rates have been calculated for dryer "ON" and "OFF". The 2 cases ("ON" and "OFF") for each dryer are necessary, because investing in a drying system will increase the hourly rate for coldset products ("OFF"). Both cases are based on higher capital costs caused by the drying system. The dryer "ON" rate includes the energy and consumables required. The coldset tower without dryer (1st column) is the 100% base hourly rate against which other process variations are compared. The heatset dryer has an integrated oxidizer that significantly reduces gas costs by using the energy from evaporated ink solvents. The charts next page show that the hourly rates for the double-width press (2:2) with dryer "ON" are very similar for heatset and EB while the two UV installations are around 8% higher. For single-width presses heatset is 10% higher than UV. The significant difference is in the lower hourly production output for Conventional UV on high speed presses that are limited to 7 m/s. However, this difference is not relevant for slow speed single width machines operating below this speed — this is the type of press where most Conventional UV units are currently installed.

Ink changeover: Although the hourly rate is not influenced by this factor, it does have an impact on production costs and the total number of jobs that can be produced per year. Ink changeover is particularly time consuming when moving from oil based to UV inks and vice versa, but much less from coldset to heatset. The scenario used is one ink change in each direction, five days a week. Changeable ink fountains and automated washing systems are used for the high speed presses (2:2 and 1:2), the other presses are cleaned manually.

3- Total production cost

The total cost to produce a representative print job reflects the differences in makeready, operating speed and changeover times on different inks and paper grades. This is the key calculation to compare all cost elements. The sample print job is a 16-page (235 x 315 mm) product, 100 000 copies, printed on each press type with different drying systems on six types of paper using appropriate inks. This 'typical' job is used as an average for annual production to calculate how many of these jobs can be produced per year.

Ink coverage: Representative SID values have been calculated for each of the ink-paper combinations.

Operating scenarios: The variable operating conditions are 100% coldset production, 70/30% (coldset/with dryer), 50/50% (coldset/with dryer) and 100% with dryer.

Printing speed: Coldset, heatset, Inert UV and EB run at maximum press speed; Conventional UV is currently restricted to a maximum of 7 m/s.

Hourly rates and output

The hourly rates and its average production output speed (copies per hour) are compared in these charts for different processes for four classes of presses.

1: Double-width high speed (2:2): All systems show similar hourly rates. Hourly output for all presses is identical except for Conventional UV that is limited to a production speed of 7 m/s.

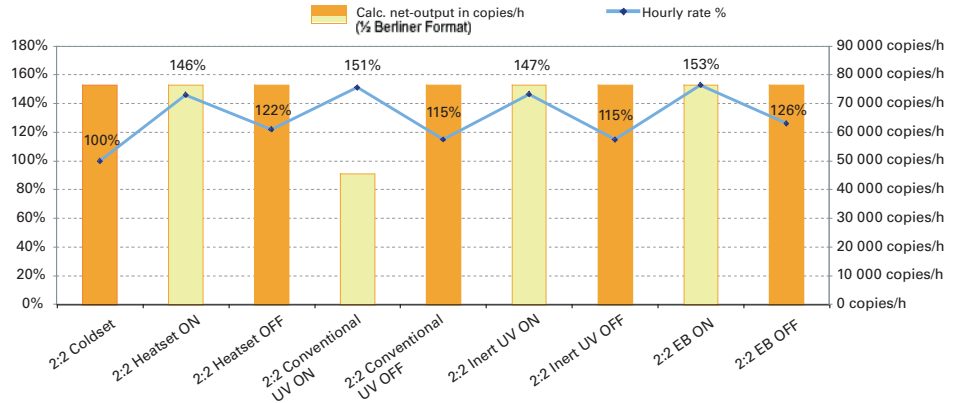

2: Single width double circumference high speed (1:2): Heatset has a marginally higher hourly rate than either of the UV systems. Hourly production speed is the same for all systems except the Conventional UV

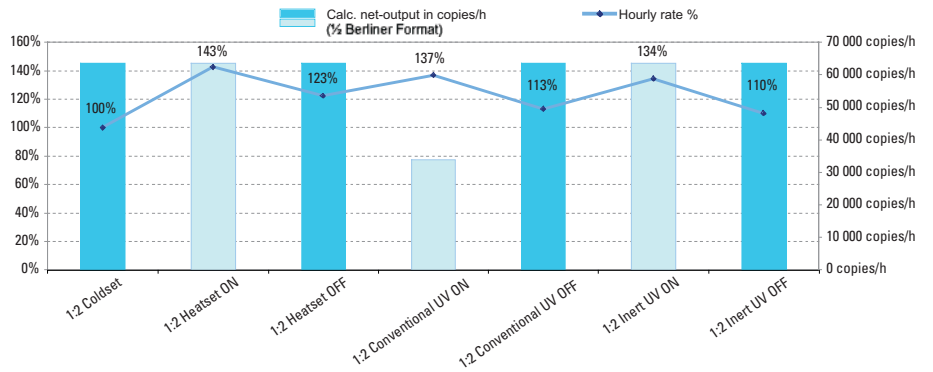

3: Single width single-circumference — medium speed (1:1): Similar to high speed performance with heatset having a higher hourly rate than UV; and low Conventional UV output..

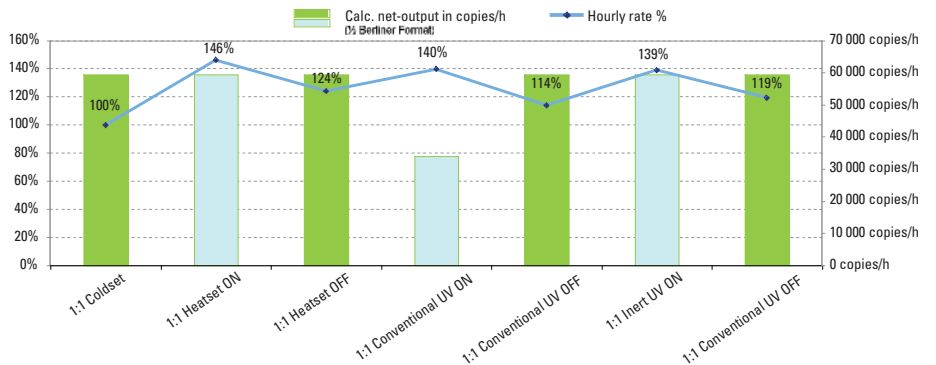

4: Single width single-circumference — slow speed (1:1S): Heatset has a higher hourly rate, but in all cases hourly production output is the same.

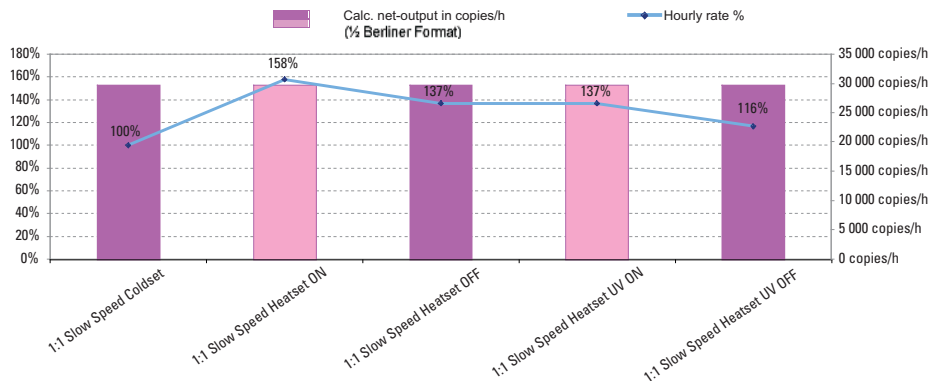

3- Total production cost

Press/Process Paper	45 gsm NP	45 gsm ULWC	52 gsm INP	52 gsm VAC	54 gsm SC-B	54 gsm LWC
2:2 Coldset	100%	—	116%	139%	—	—
2:2 Heatset	110%	150%	127%	—	128%	145%
2:2 Conventional UV	163%	—	180%	—	178%	196%
2:2 Inert UV	154%	—	171%	—	168%	186%
2:2 EB	155%	—	172%	—	169%	187%
1:2 Coldset	100%	—	117%	138%	—	—
1:2 Heatset	109%	149%	126%	—	127%	144%
1:2 Conventional UV	162%	—	180%	—	178%	196%
1:2 Inert UV	152%	—	169%	—	166%	185%
1:1 Coldset	100%	—	117%	141%	—	—
1:1 Heatset	109%	151%	127%	—	128%	146%
1:1 Conventional UV	163%	—	180%	—	178%	197%
1:1 Inert UV	157%	—	175%	—	172%	191%
1:1-S Coldset	100%	—	116%	138%	—	—
1:1-S Heatset	115%	154%	131%	—	132%	149%
1:1-S Conventional UV	147%	—	164%	—	162%	180%

Total cost of printing running 70% Coldset and 30% with dryer. This chart shows the costs of printing on different papers when using drying and curing systems. The 100% base reference is printing coldset on Newsprint. VAC is a matt coated paper that can be printed coldset. Source PrintCity VAPoN.

Observations

The additional cost to print heatset on newsprint — compared to coldset — is 9-15% depending on press size and speed. Inert UV and EB are 52-57% more expensive whilst Conventional UV is 63% higher, except for slow speed single-width where it is 47%.

The cost impact of utilisation of the dryer or curing system is minimal — there is only 1-2% difference in production costs between using the dryer 30%, 50% and 100% of press time.

Three factors increase total printing costs with radiation curing:

- 1- Higher ink prices;
- 2- Longer time to clean the press when changing ink types;
- 3- Limited Conventional UV production speed (in comparison to coldset, heatset and Inert UV) except for slow speed single-width presses.

These charts show the different production cost by press type for three paper grades:

- 54 gsm LWC
- 52 gsm INP
- 45 gsm NP

The press utilisation is 70% coldset and 30% with a dryer.

Double-width total cost of production

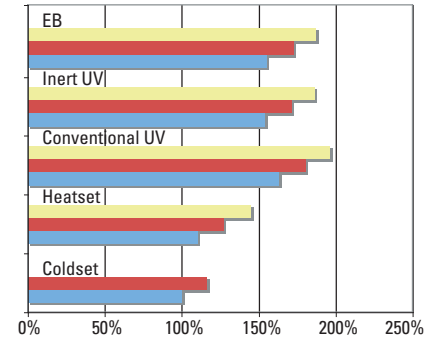

Single-width double-circumference

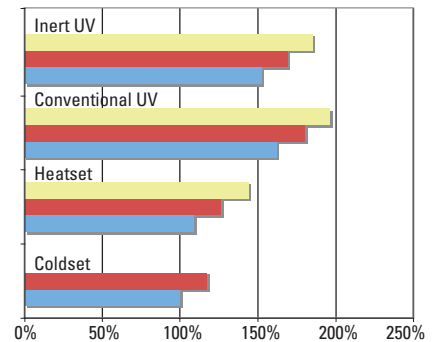

Single-width single-circumference

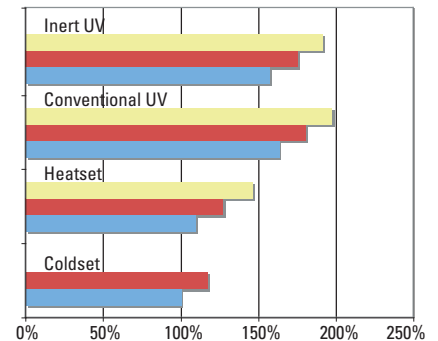

Slow speed single-width single-circumference

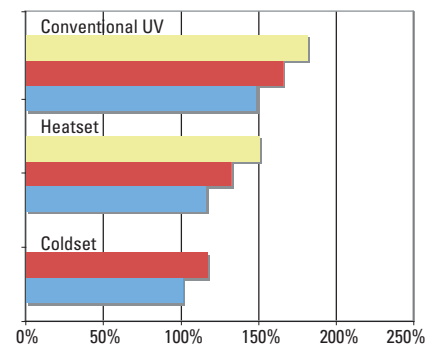

Technical-Economic Summary

This overview allows the relative strengths and weaknesses of different criteria for each process to be compared. There is no single solution for all newspaper applications. Coldset VAC and heatset are the mature high speed, high quality benchmarks. Conventional UV has a place only for slow speed presses whilst Inert UV is much more suitable for high speed applications. EB has a high but unexploited potential.

	Coldset "standard"	Hot Air	Inert UV	Conventional UV
Substrates types				
Newsprint, Standard & Improved	Yes	Yes	Yes, but picking may be a problem	Yes, but picking may be a problem
SC (Super Calendered)	No	Yes	Yes	Yes
Coated	No	Yes	Yes	Yes
Ink type	Oil-based	Oil-based	Polymer-based	Polymer-based
Ink drying/setting by:				
— Evaporation	<5%	90%	0%	0%
— Substrate absorption	90%	5%	0%	0%
— Chemical reaction/curing	<5%	5%	100% (radiation cross-linking)	100% (radiation cross-linking)
Wet-on-wet ink trapping	Yes	Yes	Yes	Yes
Special cleaning solutions	No	No	Yes	Yes
Special roller coverings	No	No	Yes	Yes
Special blankets	No	No	Yes	Yes
Automated ink delivery system & pumping	Yes	Yes	Requires special pumps & pipes	Requires special pumps & pipes
Drying/Curing method	No drying assistance	Hot air solvent evaporation	Very low heat transfer from lamps	High heat transfer from lamps
Dryer cooling	N/A	Fresh air intake	Cooling of lamps/exhaust air	Cooling of lamps/exhaust air
Chill rollers after drying	N/A	Essential	Not normally needed	Not normally needed
Cooling around printing units	N/A	No	Not normally needed	Possibly
Energy source for drying	N/A	Gas & ink solvents, electric fans	Electricity	Electricity
Comparative power consumption	N/A	Low for integrated dryer/oxidizer	Moderate	High
Drying consumables	N/A	None	Lamps 1000-2000 hours/Inert gas*	Lamps 1000-2000 hours
Space required for dryer	N/A	Large	Small	Small
Reproduction quality				
Screen ruling lpi	100	133	133	133
TAC (Total Area Coverage)	240	280-300	280-300	280-300
Ink gloss	Low	High	High	High
Paper moisture level after drying	Stable	High moisture loss	No moisture loss	Minimal moisture loss
Smearing/markings	Yes	No	No	No
Set off	Yes	No	No	No
Paper discolouration	No	No	Minor risk	Minor risk
Max. production speed — Coated paper	N/A	18 m/s	10-12 m/s*	5-7 m/s
Max. production speed — Newsprint	15 m/s	18 m/s	10-12 m/s*	3-5 m/s
Safety & Environmental				
Subject to air compliance regulations	No	Yes, VOCs needs oxidiser	No	Yes, ozone exhaust
Specific operator safety procedures	No	No	Yes, & shielding of lamps	Yes, & shielding of lamps
Ink slinging & misting	Minor	Some	May be a runability issue	May be a runability issue
Waste ink disposal	Hazardous waste	Hazardous waste	Hazardous waste	Hazardous waste
Recycling of printed paper	OK	OK	Only problem if excessive quantity	Only problem if excessive quantity
Operational issues				
Switching between ink types	N/A	Relatively easy	Requires thorough cleaning	Requires thorough cleaning
Ink-water balance	Stable	Stable	Minimal damping critical	Minimal damping critical
Temperature control of printing units	No	Desirable	Recommended	Recommended

* Inert UV speed based on a single installation only. High speed publication applications need to be monitored and assessed over a reasonably long period.

Print quality

Significant improvement in print quality on any paper comes from using either heatset or UV/EB drying. TVI is marginally higher with radiation inks. For coldset, VAC paper offers a significant improvement; and new overprinting coating systems may be very interesting for them. Heatset and UV provide very similar quality results on coated papers.

Runability & constraints

Process complexity is not seen as a significant barrier, demonstrated by hundreds of printers converting from coldset to heatset, or from oil based inks to UV in sheetfed. Some training is essential but this is not excessive. Housekeeping is much more important with UV to ensure there is no ink contamination and that lamps are always clean. However, there are a number of runability issues and increased constraints with UV or EB systems. A major difficulty is significant ink slinging and misting that tends to limit printing speed. The time and difficulty of changing between UV and oil-based inks is long (inking systems must be completely clean at ink changeover because even a minor oil-based ink residue will contaminate UV ink). Most ink rails and pumps have difficulty with the very high UV ink viscosity and reduced flow characteristics. Rollers and blankets must be compatible for UV/EB ink – if not they will deform causing a rapid decline in quality and will need early replacement. Many of these constraints can be minimised if a printing tower is exclusively dedicated to 100% UV production.

Printing speed

Conventional heatset and coldset ink-drying systems provide the most reliable high speed performance today. UV Inert systems have been run at over 12 m/s in limited production conditions, which implies a production speed of around 10-11 m/s (EB ink has potentially a similar performance). Conventional UV is barely achieving 5 m/s today with a current limit of 7 m/s. UV printing on newsprint will require improved inks to overcome picking problems.

Capital costs

Simply comparing the costs of alternative dryers is misleading because they are only one part of a system. UV dryers require a transformer and a complex electrical power supply, ozone and ink mist extraction systems, and cooling of lamps and shutters. Heatset requires chill rolls and oxidizers. Installation costs can have a significant impact on capital costs.

Installation

Installation constraints can be the “joker” factor when comparing processes if the single most important issue is to retrofit a drying system on to an existing coldset press with restricted space. Here, compact UV systems have obvious advantages. Most installations of any dryer type on high speed presses will be on a platform at 90° to the web exit from the top of a 4-high tower. Most heatset dryers require either an air turn or grater roller to guide the web into the dryer. If there is 1,5-2 m free space on top of the print tower then one UV unit can be installed to dry one side of the web before it is turned with the other dryer positioned separately. Presses running at 12 m/s only use horizontal heatset dryers/oxidizers. Single-width, single-circumference presses have lower installation challenges for UV, EB and heatset — where compact vertical dryers and chill rolls are commonly used.

Dryer for 1260 mm web width	Length/m	Width/m	Heigh/m	Weight/t
Heatset	11,0	2,5	2,5	35,0
Standard UV	2,0	1,6	1,5	2,0
Inert UV	1,5	1,6	1,4	1,5
EB	1,5	2,3	1,5	3,0

Consumable running costs

The two most significant factors are ink costs and dryer energy consumption. Heatset dryers with integrated oxidizers have the lowest ink costs and the highest energy efficiency because integrated oxidisers now recycle the energy from ink solvent incineration? Conventional UV has the highest energy consumption; Inert UV is more efficient and EB has the lowest electricity consumption. UV requires regular lamp replacement (1000-1500 hours) and Inert UV also needs inert gas. All radiation curing systems need special rollers and blankets. UV/EB inks cost 300-500% more than oil-based inks and costs are unlikely to fall due to the limited availability of the raw materials and their refinery capacity.

Total production costs

The additional cost compared to coldset to print heatset on newsprint is 9-15% depending on press size and speed. Inert UV is about 50% more expensive whilst Conventional UV is around 60% than coldset.

Summary

This comparative economic analysis provides a sound methodology with which to approach investment decisions.

- There is no single process solution for all newspaper applications, or for individual production plant
- Heatset remains the mature solution for printing on all papers and has the lowest total cost of printing compared to UV or EB.
- Compact UV systems excel for retrofitting drying systems in limited available space and/or restricted foundations. UV has the lowest capital cost but highest total print costs.
- Inert UV offers much better performance than Conventional UV— except for slow speed single width presses.
- Electron Beam (EB) is theoretically well suited to double-width newspaper production but there are currently no newspaper installations.
- For the occasional user, the lowest capital cost solution may initially be the most appropriate.

It is highly recommended that printers firstly analyse their current and future job profiles before specifying a press configuration or drying process.

Ink consumption

There is a claim that UV may use less ink than heatset for comparable SIDs, but this has not yet been proven. This claim is based on heatset ink containing about 35% solvent that is evaporated, against UV inks being solids with no volume loss. However, these inks are formulated differently and what is important is how much pigment is left on the paper. Equal ink consumption for both processes is used in the PrintCity economic model. However, even if there was a large reduction in ink consumption, this will not significantly reduce the significantly higher UV total production costs over heatset.

Other VAPoN dimensions



There are multiple dimensions in which value can be added to the newspaper publisher, advertisers and readers — usually the most effective strategy is to combine several of them.

Prepress — Alternative Screening Technologies

Improved prepress quality can visibly benefit all printing processes on all paper grades. Consistent higher prepress quality is not an option for newspaper printers competing for commercial work and publishers competing with magazine and insert advertising.

Conventional AM (Amplitude Modulation) screens are robust to use but produce visible patterns, may compromise image fidelity, and can result in loss of highlight detail. The widespread adoption of CTP has led to the development of Alternative Screening Technologies that may be AM, FM or a hybrid. AST printing can improve the quality of newspaper printing by eliminating rosette patterns, reducing colour shifts in the images, and making ink-water balance and registration less critical. Some newspapers report reduced ink coverage that minimises show-through and marking and improves drying because less ink is more uniformly distributed by smaller dots, which help solvents evaporate faster. The image, in spite of greater TVI, causes lower tonal variations during printing. Hybrid AM/FM is probably the most suitable AST for web offset. Heatset, rulings up to 94 l/cm (240 lpi) deliver quality, exposure latitude and lithographic performance with highlight and shadow dot sizes between 20-30 microns. Coldset applications range up to 69 l/cm (175 lpi) with highlight dot sizes set between 30-40 microns.

“Digital workflows have simplified and increased the speed of offset workflows. However, they require stricter discipline to correctly implement and maintain workflows if they are to deliver consistent results and are the prerequisite to introduce Alternative Screening Technologies.” — “Total process colour control & ASTs’ Web Offset Champion Group 2008.

Publication formats



Broadsheet

Berliner Format

Tabloid 1/2 Broadsheet

Micro 1/2 Berliner

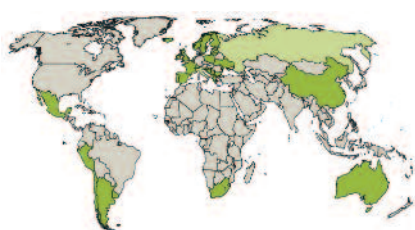

Countries with more than 50 % or more newspapers in a compact format. Source International Newspaper Marketing Association 2006.

The physical size of the newspaper has a significant impact on its perceived value and user friendliness. **“Changing format is only one part of the process of newspapers waking up to consumer demands. The arrival of Metro in the mid-1990s — non-partisan, non-sensational newspaper for commuters perhaps played its part in changing perceptions of what newspapers in small formats were about. Form did not dictate content.”** — “The Format Change Phenomenon” WAN 2005. Commercially, the key issue when changing formats (outside the general intent to lift circulation and readership) is to protect revenues. Editorially, format change allows newspapers to become more dynamic, engaged and modern.

The global trend towards more compact formats is well established and likely to continue. The simplest route taken by many publishers is to move from broadsheet to tabloid — which is the folding term for a half-broadsheet, not a specific size. The reason for this is that there is no need to

	Berliner	US	Rhinc	Nordic	
Broadsheet	300 x 450 (400)	317,5 (305) x 533	350 x 520 (510)	400 x 560 (540)	mm
Tabloid	300 x 225 (200)	317,5 (305) x 266,5	350 x 260 (255)	400 x 280 (270)	mm

Typical newspaper formats the dimension in brackets are common variations in size



replace the existing press. The disadvantage is that it is not possible to section the newspaper without preprinting and inserting.

Newspaper sizes have no international standardisation and vary vastly in both proportion & dimensions nationally. There is an international trend towards the Berliner format because it combines a number of advantages: its proportions allow more design flexibility; as a broadsheet it can be easily sectioned; it is close to the A3 format; and as a tabloid micro-format it is close to the classic A4 magazine size. The DIN A3 and A4 formats are the standards for most commercial heatset production with which many newspaper publishers want to compete, or for commercial web printers that want to print newspapers. (The Berlin format is 18 mm wider and 50 mm longer than DIN A3).

Stitch/glue & Trim

Trimmed and bound (either glued or stitched) newspapers and their supplements add perceived value to publications. These techniques also allow newspapers to conform to distribution regulations that in some parts of the world do not allow loose inserts in free newspapers to minimise litter and cleaning.

Sticky notes

Eye-catching response cards, vouchers, product samples or sticky memos can be directly applied on to a specific newspaper page and/or advertisement. These promotional devices offer advertisers a high differentiation when combined with an accompanying advertisement. Application is at the folder at full press speeds

Special Inks

The combination of thermochromic and barometric inks that change colour with temperature and air pressure could provide newspapers with a printed weather forecasting device for advertising or promotion. This application is probably best preprinted and inserted into the newspaper or applied as a sticky note.

Special folds

A number of newspaper publishers offer special folds as a means of providing value added advertising offers.



Unusual papers can provide high value added impact for advertisers. Süddeutsche Zeitung in Germany printed this award winning advertisement on transparent paper that reinforces the BMW TV advertising spot. Source manroland Innovative Newspapers.



This distinctive format use 7/8 roll width to deliver a vertical half page that can be positioned either on the front cover or inside the newspaper. Source manroland Innovative Newspapers.



The super panorama or double gate fold has been used successfully for major product advertising launches.. Source manroland Innovative Newspapers.



connection of competence

VAPoNTM news

A cross industry project from the PrintCity alliance

VAPoNTM

is a newspaper product with a clearly visible difference to standard coldset, that is recognised by readers and advertisers, and capable of attracting higher revenues to the newspaper and/or adding to its differentiation.

This new test printing

series allows the comparison of 3 printing processes, using 2 screen technologies on 2 paper grades.

Value Added Printing of Newspapers



Photo © Ifra / all rights reserved

PrintCity VAPoNTM project members are

-
-
-
-
-
-
-

In association with

Passauer Neut-Press-Druck

ifra

VAPoNTM is a PrintCity trademark

New Test Printing



PROJECT PARTICIPANT

www.eltex.de

Since 1953, **Eltex** has concentrated on applied electrostatics in industry, with a particular emphasis on the printing, packaging, finishing, and plastics industries. Eltex develops highly effective electrostatic solutions for neutralizing the undesirable side effects of static electricity as well as systems for its controlled, beneficial use. Eltex systems for the printing industry are well known and used all over the world. Electrostatic Printing Assist (ESA) for gravure printing, Ribbon Tacking for gravure and web offset and the new electrostatic innovation INNOCURE for newspaper printing are the major products for Eltex Elektrostatik GmbH, based in Weil am Rhein, Germany.



MEMBER

www.trelleborg.com

Trelleborg Printing Solutions is a global provider of innovative solutions in an unmatched breadth of printing process applications. The comprehensive product and service portfolio meets the most demanding printing needs. A focus on innovative technology and superior service helps ensure printers achieve higher quality and better productivity throughout their entire process — along with an emphasis on the environmental features critical to them, their customers, and to the industry. Trelleborg Printing Solutions products include blankets for offset and coating, photopolymer plates, letter press newspaper plates and ink jet printing.



MEMBER

www.manroland.com

manroland Druckmaschinen AG is the world's second-largest manufacturer of printing systems and the market leader in web offset. The group with production facilities in Offenbach, Mainhausen, Augsburg and Plauen employ almost 9 000 people. Annual sales are over 2 billion with an export share of 82% and new orders of 1.9 billion. Web and sheetfed offset presses, and digital printing systems provide tailor made solutions for publishing, commercial, and packaging printing.

A worldwide network of about 100 sales and service centres markets manroland's products as well as ancillary printing equipment and press room products.



MEMBER

www.megtec.com

MEGTEC Systems is the world's largest supplier of weblines and environmental technologies for web offset printing. The company is a specialised system supplier for roll and web handling (loading systems, pasters, infeeds) and web drying and conditioning (hot air dryers, oxidisers, chill rolls). MEGTEC combines these technologies with in depth process knowledge and experience in coldset and heatset printing. MEGTEC has manufacturing and R&D facilities in the US, France, Sweden and Germany, China and India along with regional sales, service and parts centres. MEGTEC also provides energy and efficiency consulting and machine upgrades.



MEMBER

www.oce.com

Océ enables its customers to manage their documents efficiently and effectively by offering innovative print and document management products and services. In advanced research centers and high-tech production facilities the company develops products and services for the reproduction, presentation, distribution and management of documents. Océ focuses on professional user environments, particularly those processing high document volumes.

Océ has approximately 24,000 employees worldwide, reported revenues of EUR 3.1 billion in 2006 and markets its products in 80 countries.



MEMBER

www.sunchemical.com

Sun Chemical, the world's largest producer of printing inks and pigments, is a leading provider of materials to packaging, publication, coatings, plastics, cosmetics, and other industrial markets. With annual sales over \$4 billion, Sun Chemical has more than 11,000 employees supporting customers around the world. The Sun Chemical Group of companies includes such established names as Coates, Hartmann, Kohl & Madden, and US Ink. Sun Chemical Corporation is a subsidiary of Sun Chemical Group B.V., the Netherlands, and is headquartered in Parsippany, New Jersey, USA.



MEMBER

www.upm-kymmene.com

Paper touches the lives of hundreds of millions of people in many forms like magazines, newspapers, catalogues, books, envelopes, labels, bags, sacks or office papers. UPM contributes to this with its exceptionally wide range of papers manufactured of sustainable fibres. The company's know how and use of advanced technology combined with the desire to find the best solutions for each customer, creates superior products with low environmental impact. Across continents, UPM sales and distribution companies are working locally with customers to build strong and lasting relationships.

www.printcity.de

PrintCity is a Strategic Alliance that shares worldwide expertise from independent companies in the graphic arts industry. Members work together in partnerships within a complete workflow — from prepress to press to postpress — across the packaging, commercial and publishing sectors. PrintCity was founded in 1998 and is an established long-term alliance, representing businesses active in all global markets. **PrintCity is an Alliance:** Connecting the competence of members to offer added value solutions worldwide; Delivering knowledge through seminars, trade fairs, project studies, publications and the Internet; Promoting the value of print and packaging as media to responsibly satisfy the world's needs; Encouraging networking within the whole industry to stimulate worldwide co-operation among all partners.



in association with



Value Added Printing of Newspapers

WAPON™



connection of competence