



BEST PRACTICE GUIDE FOR WEB OFFSET PRINTERS

# Environmental considerations

Energy Economy  
Efficiency Ecology



Guide N°6. Edition N°1. €30.



Aylesford Newsprint, Kodak GCG, manroland, MEGTEC, Müller Martini, Nitto, QuadTech, SCA, Sun Chemical, Trelleborg Printing Solutions



# Environmental Considerations Energy, Economy, Efficiency, Ecology

Best practice guide for web offset printers

Aylesford Newsprint, Kodak GCG, manroland, MEGTEC, Müller Martini, Nitto, QuadTech, SCA, Sun Chemical, Trelleborg Printing Solutions,

The content and value of this publication have been vastly helped by the assistance of individuals, printers and associations who gave their time and expertise to review and improve this guide.

CIPHO, Bernd Berressem;  
WAN-IFRA, Germany, Manfred Werfel;  
Norske-Skog, Simon Papworth;  
Printing Industries of America/Graphic Arts Technical Foundation, Gary Jones;  
Polestar Varnicoat, UK, Mike Eccleston;  
PMP, Australia, Joanna Richards, Sandra Cowell, Bill Waterman, Rachelle Harvey;  
Quad/Graphics, USA, Tom Estock;  
Rick Jones Print Services, UK, Rick Jones;  
UPM, Finland, Sami Lundgren, Erik Ohls;  
Sun Chemical, USA, David Starkey, David Blanchard;  
Technotrans, Germany, Peter Benton;  
Watch Tower House, UK, Bernard Bedril.

#### Principal contributors :

Aylesford Newsprint, Mike Pankhurst; Kodak GCG, Steve Doyle, David Elvin;  
Trelleborg Printing Solutions, Marc Than; manroland, Arthur Hilner, Ralf Henze,  
Norbert Kopp; MEGTEC Systems, Eytan Benhamou; Müller Martini Print Finishing Systems,  
Gerhard Tschan, Felix Stirnimann; Nitto, Bart Ballet; QuadTech, Randall Freeman;  
SCA, Marcus Edbom; SunChemical, Larry Lampert, Gerry Schmidt, Paul Casey.

#### Other contributors :

Eurografica, David Cannon; French Printing Federation (FICG), Benoît Moreau;  
Orion Energy Systems, USA Steve Heins; PrintCity, John Dangelmaier; Technotrans,  
Peter Betson; Welsh Printing Centre, Welsh Centre for Printing and Coating,  
Swansea University, Tim Claypole.

#### Special acknowledgement to

PIA, and WAN-IFRA for their assistance and permission to reproduce some of their material.

Managing Editor Nigel Wells.

Illustrations: Anne Sophie Lanquetin with permission of FICG and ECOConseil.

Design and prepress by Cécile Haure-Placé and Jean-Louis Nolet

Photographs: Aylesford Newsprint, Hunkeler, Kodak GCG, manroland, MEGTEC, Muller Martini, Quad Graphics QuadTech, Sun Chemical, Technotrans.

© Web Offset Champion Group, September 2005. All rights reserved. ISBN N° 915679-01-0  
Guides are available in English, French, German, Italian and Spanish editions

To obtain printed copies in North America contact PIA [printing@printing.org](mailto:printing@printing.org)  
In other areas contact your nearest Web Offset Champion Group member  
or [weboffsetchampions.com](http://weboffsetchampions.com)

#### Bibliography & sources of information

For more information on the environment, consult the Web Offset Champion Group's Internet site that lists more worldwide information sources [www.wocg.com](http://www.wocg.com).

Australian Environment Business Network, Andrew Doig, seminar "Profiting & Efficiency From Waste Management".

British Printing Industry Federation, London  
"Printer and the Environment" 1993;  
"Energy Efficiency in the Printing Industry" 1996.

"Clean Air Compliance Handbook"  
Source MEGTEC Systems.

"Emissions of Volatile Organic Compounds from Stationary Sources in the UK: A review of the emission factors by species and process (September 1993 update)",  
N.R. Passant, Warren Springs Report LR990, December 1993.  
ISBN 0 85624 850 9.

"Environmental Regulations for Printers",  
Fred Shapiro, 2003, Jelmar Publishing, New York.

Envirowise UK. Multiple publications for download including:  
"How to become a green printer", "Cost-Effective Substrate Management For Printers", "Cost-Effective Chemicals Management For Printers", "Cost-Effective Management Of Cleaning Materials For Printers", "Reducing IPA use: Industry examples",  
[www.envirowise.gov.uk](http://www.envirowise.gov.uk)

Environmental Technology Best Practice Programme, joint DTI and DETR programme managed by Aea Technology Plc through ETSU and the National Environmental Technology Centre  
[etbppenvhelp@aeat.co.uk](mailto:etbppenvhelp@aeat.co.uk)

General fact sheets for printers NSW, Australia EPA  
[www.epa.nsw.gov.au/small\\_business/printers.htm](http://www.epa.nsw.gov.au/small_business/printers.htm)

Green Press Initiative (GPI) USA: [www.tshore.com](http://www.tshore.com)

L'ECOguide "les métiers de l'Imprimerie"  
- 2003/ ECOConseil et Fédération de l'Imprimerie  
et de la Communication Graphique (FICG)

"Printing and the Environment/ Guidance on Best Available Techniques (BAT) in Printing Industries" 1999, INTERGRAF/EGF

"Managing solvents and wipes",  
EPA Design for the environment printing project, Case study 1,  
EPA report number EPA 744-k-93-001.

"Minimising VOC emissions from Victoria's printing industry"  
Publication 940, EPA Victoria, February 2004.

Printing Industries Association of Australia  
"Environmental Management Manual"  
prepared by Dames & Moore, March, 2000.

"Potential Environmental Impact Of Fountain Solutions Effluents",  
Laurie Chastanet - École Française De Papeterie  
Et Des Industries Graphiques.

Printer's National Environmental Assistance Center,  
[www.pneac.org/](http://www.pneac.org/)

"Profiting and Efficiency from Waste Management"  
Andrew Doig, Australian Environment Business Network.

"Printing Plant Layout and Facility Design",  
A. John Geiss, PIA, Pittsburg 1997.

"Commitment to the Environment", "Gruff's Purchasing Guide",  
Quad/Graphics.

"Occupational Health & Safety & Environmental Protection  
During Processing of Printing Plates in Germany"  
CIPHO, Frankfurt 2003, [www.cipho.de](http://www.cipho.de)

"The World of Böttcher", 2003, Cologne,  
[www.boettcher-world.com](http://www.boettcher-world.com)

US Environmental Protection Agency, Office of Air Quality Planning  
& Standards, [OAQPS@epa.gov](mailto:OAQPS@epa.gov); Design for the Environment, Solutions  
for Lithographic Printers "Evaluation of Substitute Blanket Washes"  
[www.epa.gov/oppt/dfepubs/lithography](http://www.epa.gov/oppt/dfepubs/lithography)

This guide looks at the underlying issues of the **4Es of Energy, Economy, Efficiency, Ecology** and how to apply the **4 Rs - Redesign, Reduce, Reuse, Recycle** - to improve overall performance. Best practices are an important tool that combines the generic expertise of Web Offset Champion Group members, printers, associations and other experts to help improve the efficiency of the production process chain.

A responsible environmental policy has compelling business advantages - the opportunity to reduce costs, increase competitiveness, become more innovative and enhance staff and customer confidence, whilst avoiding the potentially expensive risks of non-compliance. In many cases, companies may also qualify for funding opportunities, tax incentives and reduced insurance premiums. In addition, environmentally aware printers benefit from an increasingly positive brand value perception, particularly as more and more of their customers are adopting third-party certified Corporate Social Responsibility reporting. Businesses that take only a minimum compliance approach miss all of these opportunities and have a higher risk of fines and remedial costs.

Environmental considerations have an important role in improving overall business performance. Equipment, materials and operational effectiveness are the three pillars of productivity that need to work effectively together to optimise manufacturing efficiency. Each pillar incorporates standard procedures, maintenance and environmental issues; poor performance in any one will have a negative impact on productivity. Product quality is a key environmental issue and getting it "right first time" is a joint environmental and economic necessity. A systematic waste minimisation programme can often cut waste by 25% — this means that if total waste is 12% of turnover, 3 % can be added to company profits through cost savings. Waste reduction has become even more important because industrial raw materials (oil, metals, energy) have increased in price by 54% in the three years ending 2004. Paper, however, maintains a relatively stable price that has changed little in real terms since the early 1990s. Waste is often seen as valueless but its recycling/re-use value can be much higher than the cost of its disposal.

### Evolving from "Green wash" to "Hard Lean & Green Business"

There is significant scope to reduce the toxicity and volume of chemistry in the offset printing process. This includes alcohol-free fountain solutions, vegetable cleaning agents and inks, and a new generation of virtually process-free plates. Computer hardware and software have already played critical roles in finding non-chemical prepress alternatives. Good maintenance is also environmentally important because it helps reduce energy, waste, cleaning materials and noise, and facilitates health and safety compliance - see Guide N° 4 "Productivity Maintenance".

To assist readers we have used a number of symbols to bring attention to key points:



Best practice



Poor practice



Potential cost reduction



Safety risk



Quality issue

## CONTENTS

<b>1- Integrated environmental business strategy</b>	<b>4</b>
Main environmental management issues	5
Considerations for print buyers & designers	6
Considerations in printers' supply chain	7
Paper and the environment	8
<b>2- The web offset environment</b>	<b>10</b>
Process inputs and outputs	10
Measure and minimise waste	12
Optimise consumables	12
Reduce packaging	13
Separate waste	13
Volatile Organic Compounds (VOCs)	14
Cleaning products	14
Consumable materials	16
Water and liquid waste	17
Paper and sold waste	18
<b>3- Production process</b>	<b>20</b>
Prepress	20
Ink	21
Dampening	22
Blankets & washing systems	24
Air emission compliance & Control	26
Postpress	28
<b>4- Energy Efficiency</b>	<b>32</b>
Where are the wasted kWh's?	
Machines	34
Buildings & services	38
Lighting	40
Noise and the environment	41

### IMPORTANT SAFETY NOTE !

*Always check a machine is in its specified safe position before working on any component (e.g. with compressed air, electrical power and gas disconnected). Only trained maintenance personnel adhering to safety regulations should perform maintenance work. A general guide cannot take into account the specificity of all products and procedures. We therefore strongly recommend that this guide be used in conjunction with information from your suppliers, whose safety, operating and maintenance procedures take preference.*

# Integrated environmental business strategy

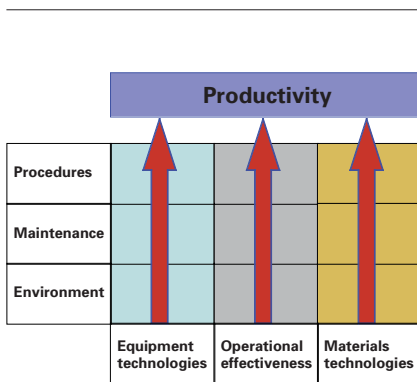

1

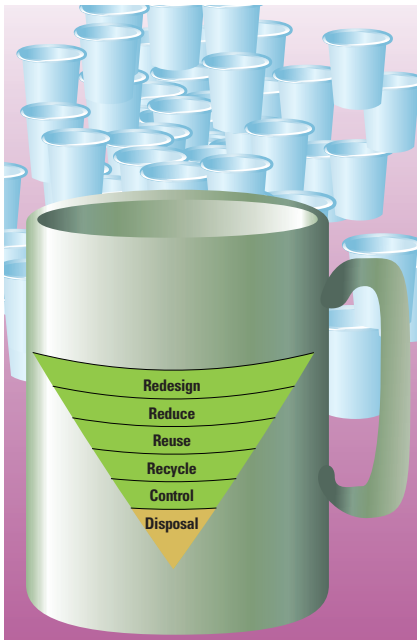

2

**1-** Manufacturing efficiency is largely determined by how effectively the three pillars of productivity work together. Each pillar — equipment, materials and operational effectiveness — includes standard procedures, maintenance and environmental issues. Poor performance in any one will impair overall performance. Environmental or maintenance programmes developed in isolation tend to be much less effective.

**2-** An innovative internal communication by one company was to give its employees a ceramic mug to replace disposable vending machine cups. At 2-4 cups per person/a day this represents a saving of 500-1 000 plastic cups a year to dispose of for each employee.

*“A major payback from a proactive environmental programme is improved business efficiency. An increase in productivity often takes place when a printer works towards environmental compliance, so much so that the profitability of operations frequently increases significantly.”*  
‘Environmental Regulations for Printers’, Fred Shapiro.

Waste is a good measure of plant efficiency and a little effort can yield cost savings that increase productivity. A waste minimisation programme can often cut waste by 25% — if total waste is 12% of turnover this would add 3 % to company profits. Waste is often seen as valueless but its recycling/reuse value can be many times higher than the cost of its disposal (Environwise UK).

The integration of an effective environmental policy will improve business performance through:

- Reduced purchasing cost from using less ink, paper, solvent, water and energy;
- Cost savings from waste reduction, reuse, recycling and lower disposal costs;
- Reduced Volatile Organic Compound (VOC) emissions;
- Improved product quality and process control;
- Sound basis to comply with regulations to avoid risk of non-compliance costs;
- Improved employee working conditions and motivation;
- Reduced insurance premiums;
- Improved brand image and differentiation to customers, financiers, investors, neighbours and regulators.

Environmental compliance does not ensure superior environmental performance. Effective environmentalism should be a natural part of business, going beyond simple compliance and aiming to enhance overall economic performance whilst improving the quality of life for employees and the community. The balanced use of all resources (including finance) will conserve raw materials, minimise waste and reduce environmental impact. Printers working with their clients and suppliers to improve the manufacturing processes, logistics and the use of materials, achieve the best results. The 4Es (Energy, Economy, Efficiency, Ecology) require a longer-term business view. Life Cycle Management (LCM) helps control and reduce the operating costs of a printing system for its entire lifetime and provides better environmental performance.



## The 4 Rs - Redesign, Reduce, Reuse, Recycle

**Redesign:** How can processes be made more resource and cost efficient? Examples are the elimination of film and processing by CTP plate, direct drives that reduce energy consumption, closed loop colour control and automation to reduce makeready and running waste. New production investments should be considered as both tangible and non-tangible costs: tangible costs are standard business practice and should account for waste reduction; the intangible potential costs are the risk of non-compliance with environmental and other regulations.

**Reduce:** Less material in and less waste out: improved resource efficiency through continual attention to waste streams and processes to reduce emissions, energy use and waste. A waste reduction plan is an opportunity to improve overall business efficiency by reducing manufacturing and waste disposal costs without compromising quality. Waste is not just solids and liquids that require disposal; it is also wasted time and costs.

**Reuse:** Identify waste materials that can be reused for another purpose to reduce purchase and disposal costs; or find ways of converting waste energy into re-useable energy.

**Recycle:** Waste materials (ink, plates, paper and plastics) transformed into other products typically use less energy and resources than for products made from virgin materials. However, in some cases, the viability of recycling-to-reuse may be an issue if significant additional energy is needed.

Resources that cannot be redesigned, reduced, reused or recycled should be disposed of responsibly.

# Main environmental management issues for printers

- Air emissions:** Minimise VOCs and other substances used in the printing process, including fugitive emissions that are not otherwise captured and treated.
- Dangerous and hazardous materials:** Many products (e.g. some solvents, inks, chemicals) are classified as dangerous or hazardous for health, fire, and environmental reasons. It is essential to comply with regulations on their security, storage, handling, use, disposal and record keeping. Use qualified/certified companies to correctly transport and dispose of waste.
- Liquid waste:** Minimise the amount of wastewater and all liquid waste. Most countries strictly regulate disposal of wastewater and any other liquid into surface or underground water courses, community drainage and storm water systems.
- Solid non-hazardous waste:** Prioritise reduction by elimination of defective products and recycling.
- Packaging waste reduction:** Many countries require measurement and reduction of all domestic and industrial packaging materials. Used pallets, cartons, plastic sacks and films, metal and plastic containers should be stored separately and either reused or recycled. Maintain records on each waste stream to measure source reduction efforts.
- Energy management:** Conserve energy in all areas: equipment, process, lighting, heating, cooling.
- Workplace:** Compliance with health and safety regulations. Noise is an increasingly important issue.
- Regulations and Permits:** Ensure compliance with all relevant legislation.
- Neighbours:** It is better to have complaints coming to you rather than to the local authority. Keep a public complaints register and note wind or other factors that can contribute to noise, odours and emission problems.

Most of these issues are subject to environmental, health or safety regulation. Understanding the regulations and the process path of each can help identify actions to minimise waste, save money and stay ahead of environmental legislation. Environmental compliance does not ensure superior environmental performance.



## Environmental policy

An effective environmental policy sets out the company's commitment to respect its legal obligations and good environmental practice. A good policy should be clear, simple and short (explaining the company's aims and commitments; responsibilities; resource availability; objectives; monitoring and review). It should be relevant to all operations and communicated to employees, customers and suppliers. The policy needs to be followed, otherwise it will be meaningless and counter productive.



## Key environmental management success factors

- Clear management motivation with a policy that integrates environmental issues into a global purchasing and manufacturing strategy.
- Appoint a responsible person for environmental issues.
- Create multi-competence project teams (production, quality, health, safety, environment, finance, purchasing, suppliers) to identify actions and implement change.
- Address one issue at a time. Set quantitative targets over time — challenging but achievable.
- Provide adequate resources and time to achieve measurable objectives.
- Systematically use appropriate tools to identify, analyse and record issues.
- Communicate the waste programme and results in a way that motivates the interest and involvement of staff, shareholders, customers and suppliers.
- Motivate and train staff to develop a more efficient and sensitive attitude to environmental questions. Give them an active role in redesigning systems and a responsibility to ensure that the policy objectives are met.
- If needed, establish partnerships with experts from different fields for environmental problem solving.

These tables show the results obtained from a proactive environmental approach by Quad/Graphics, one of the largest printers in North America. They currently recycle 98% of all solid materials entering their printing plants.

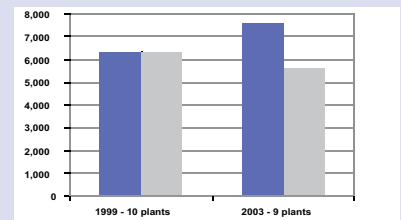

**Energy use (therms)**  
**100 million net pages**  
In spite of 20% increased output, energy use has been reduced by 10% (from 6337 therms per 100 million net pages to 5642).

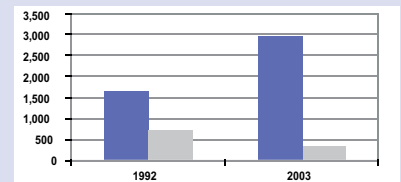

**Offset air emissions (lbs)**  
**5 million gross impressions**  
Offset air emissions are mostly from web presses with non-integrated oxidizers. These have been reduced by 53% (from 328 kg/722 lbs per 5 million gross impressions to 160 kg/352 lbs).

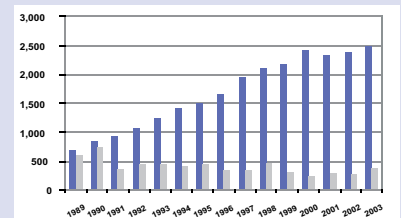

**Hazardous waste (lbs)**  
**10 million gross impressions**  
Hazardous waste reduced by 37% from 275 kg/605 lbs per 10 million gross impressions to 172 kg/378 lbs.

Source Quad/Graphics.

# Environmental considerations

## Some questions print buyers can ask their suppliers

1. Do they have a documented environmental policy (ask for a copy)?
2. What is being done to reduce air emissions?
3. What is being done to reduce the IPA content of dampening solutions?
4. Are the safest cleaning agents used (for employees and the environment)?
5. How is energy consumption minimised?
6. How are paper and other solid waste reduced?
7. How is chemical use and discharge minimised?
8. How is process wastewater treated?
9. Is there a purchasing policy that gives preference to "green" products?
10. Is the printer environmentally proactive? Ask for a copy of its policy and results. Is it a member of a recognised industry programme?

Considerations for Print Buyers & Designers	Reduce	Reuse	Recycle	Impact
Paper choice (weight, surface, grade, size)	✓		✓	✓✓✓
Paper supplier environmental responsibility				✓✓✓
Use of special ink colours	✓			
Choice of coatings			✓	✓
Design to minimise ink coverage	✓			✓
Improve distribution efficiency	✓			✓✓
Promote actions for reader recycling			✓	✓✓✓
Select an environmentally responsible printer				✓✓✓

## Print buyers & designers

The choices made by print buyers and designers influence not only the quality and cost of printed products but also their impact on the environment. The volume and materials used have implications for air and water quality, waste disposal and energy use. Choices can be made to help reduce the environmental impact of the printing and publishing industry. The most important factor is early and frequent consultations with printers and paper suppliers to evaluate at the outset the process, materials and design criteria. It is important to take into account regional variations that may change a preference.



Some environmental questions for print buyers and designers:

- Are there opportunities to use recycled paper? This can significantly depend on the location of paper making plant and its fibre sources (see page 191) In the past recycled paper has not always performed in the same way as papers made only from fresh forest fibre. However, paper mills that have improved their production techniques and can now make paper with recycled content that overcomes these issues. In some cases, brightness may be reduced in proportion to the amount of contaminants present and whiteness may be poorer and less consistent than from papers made only from fresh forest fibre. Excellent printed results using paper with recycled content are possible with some minor adaptation to the printing process — there may be a tendency for higher ink absorption, reduced ink gloss and increased Tone Value Increase (TVI).
- Can lighter weight paper be used to yield more copies per tonne? There has been a steady reduction in the paper weight for newsprint. Some weekly magazines have reduced paper weight in countries with high postal costs, like the US. However, these papers tend to be more expensive to purchase and more sensitive to production conditions and web breaks (see Guide 3 "How to avoid surprises when changing paper grades").
- Is the paper selected from a company with a clear commitment to environmental stewardship, minimal ecological impact and long-term sustainable production?
- How easy is it to recycle the printed product when its intended use is over?
- Avoid using inks containing heavy metal components that can cause environmental and worker health hazards - use substitutes that are better for the environment?
- Coating and lamination? Varnish, water based and UV coating can all be treated by modern flotation recycling plants provided they are not in excessive quantities — coating weight higher than 2,5 gsm may impair recycling. UV coatings contain no VOCs. Solvent based lamination uses large quantities of VOCs and adhesives that are a recycling problem.
- Can the design minimise ink coverage to reduce resources used (inks and energy).
- Is the print run length order optimised? Are mailing lists regularly updated? Remove duplications and use more target-specific lists to minimise print and mailing quantities to reduce cost and environmental impact. Minimise publishing return copies — around 30-40% of most publications are unsold and recycled.
- Can you encourage readers to correctly recycle printed products when they are finished with them?

## Considerations in printer's supply chain



New products are constantly being added to the list of alternative and recycled goods. Challenge suppliers to suggest new products or ways of using them that will decrease their environmental impacts. Before making a purchase decision printers should ask their suppliers:

- 1 Will the product deliver environmental improvements without compromising performance or cost? Does it last longer than the current product (total cost for service)?
- 2 Does the product contain dangerous or hazardous substances, VOCs, or chlorinated substances?
- 3 What are the economic and environmental costs associated with the product, its packaging, transport and disposal?
- 4 What bulk options are available? Can inks and chemicals be delivered in bulk, or in concentrated form, to reduce packaging and transportation? Can chemical containers be reused, recycled or returned to the supplier for further use? Does the supplier have a container collection programme?
- 5 What waste by-products result from using the product and how can they be properly disposed of? How can waste be prevented?
- 6 Is it recyclable? What can it be recycled into and is there a market available for it? Does the supplier have a recycling programme for it?
- 7 Can the product be made from recycled material? Is there a difference in cost and quality? What proportion is recycled?
- 8 What is the energy-efficiency of the product? Is there a more energy efficient alternative available?
- 9 What is being done to improve the efficiency of supply chain management?
- 10 For new equipment decisions quantify comparative performance that reduces materials waste; eliminates process steps; reduces process waste (air, water, energy), maintenance and noise. Select equipment on its lifetime operating costs and environmental impacts rather than just on acquisition cost.

## Corporate Social Responsibility

'Stakeholder' reporting started in the 1970s and has evolved over time to become a more serious business dimension. Since 1990, companies are increasingly adopting Corporate Social Responsibility reporting that is certified by independent third parties. The International Social & Environmental Accreditation & Labelling (ISEAL) is a group of international standard-setting and accreditation bodies. Social and environmental reporting covers the different interests of employees, communities, customers, suppliers and investors. 'Social' auditing makes corporate buyers more serious about both their own performance and working with certified suppliers. 'No certification' can mean 'no business' for some printers.

## Print industry environmental programmes

Be cautious on what an environmental label actually means. Certain programmes are elitist, e.g. only 20% of printers can join (irrespective if there are many others that meet the criteria) or require payment. Certification to ISO 14001 only indicates efficiency in managing an environmental system but gives no assessment of the effectiveness of a company's environmental actions. An Eco label is based on a set of criteria that covers many environmental issues to help guide customers and consumers in the choice of products. Examples include Der Blaue Engel in Germany, and the Nordic Swan in Scandinavia. Some publishers and printers use these symbols to promote their environmental responsibility and to build their brand images. Other initiatives are company or voluntary open industry programmes.

The following two examples of a company and open industry programmes demonstrate different approaches to improving environmental compliance. Both organisations have been major contributors to the content of this guide..



**Be a Gruff...Recycle Stuff!®**

The internal company-wide programme of Quad/Graphics (the largest privately owned printer in the Western Hemisphere) has achieved a 98% recycling rate and significant savings in energy, materials and air emissions. The company's enlightened environmentalism is a part of its holistic approach to business and has won it numerous awards for its initiatives. Gruff the goat is the company's environmental mascot to help educate employees on environmental matters.



EcoConseil/FICG (Green Printer) is a voluntary industry initiative launched by the French

Printing Federation (FICG) in association with Chambers of Crafts and Commerce. Participating printers are given assistance to define their environmental priorities. A network of over 60 engineers has been created to visit these printers to assist them to implement their policies. At the same time, FICG helps promote companies that have obtained the EcoConseil/FICG classification by using it as a value added brand to print buyers, administrators and insurance companies

# Paper and the environment

Water can be a variable environmental concern depending on local conditions. A mill uses large amounts of water that leaves the mill as steam or waste water. Effects are limited if it is sufficiently cleaned, except in areas where water availability is low or where the emission of hot water may require cooling. Other environmental effects of papermaking are mostly related to the production of steam and electricity.

Paper has outstanding features for a sustainable product cycle. It is made from wood fibre produced by forests that utilise solar energy, water and soil nutrients. Wood fibre is non-toxic, biodegradable and can be reused several times. Paper can be made from either virgin or recycled pulp and both types of raw materials are needed to produce different kinds of paper that should be manufactured as environmentally sound as possible. When decomposed or incinerated for energy production paper residues are the same compounds used by the trees to begin with - carbon dioxide, water and mineral nutrients. To minimise environmental impacts at different steps of the paper cycle environmental groups emphasise:

- Better resource management through reduced consumption and increased recovery and recycling.
- Sustainable forest management with independent forest certification.
- Improved control of the international timber trade to eliminate illegal timber.
- Elimination of chlorinated compounds in bleaching.
- Reduction of energy used for manufacture and transport.
- More local participation in decisions on land use including indigenous peoples and fairer trade.

## Forests and forestry

Most of the forests providing raw materials for paper are located in the world's temperate and boreal regions — predominantly managed natural forests in North America and Northern Europe. Raw materials from tropical rain forests are not used by the paper industry. The fundamental environmental demands on forest management are sustainable wood production — the replacement of harvested trees by new — without long-term damage to water, air, soil or the forest's natural processes; and preserved plant and animal biodiversity.

### Forest certification

Certification ensures that forest management is sustainable and meets relevant environmental claims. Forest management is normally independently audited to a performance standard. The two main global systems are:

**FSC (Forest Stewardship Council).** A global multi-stakeholder organisation promoting responsible forest management to balance environmental, social and economic benefits. These principles are developed into national or regional performance standards with local stakeholders. Timber from FSC-certified forests can be used in the production of FSC-certified wood and fibre products according to a certified chain-of-custody standard. FSC is supported by organisations like WWF and Greenpeace.

**PEFC (Programme for the Endorsement of Forest Certification Schemes).** An umbrella organisation endorsing national schemes designed for owners of small woods. The schemes vary between countries. In Sweden they involve the owner of the forest; in Finland, Austria and Germany, the certification is by regions, without commitment from individual forest owners. PEFC has a system for product certification. Similar schemes include the CSA (Canadian Standards Association), which is in a PEFC endorsement process; and the US SFI (Sustainable Forest Initiative).

An Environmental Product Declaration provides information on the environmental qualities of a product — mainly to professional buyers who have the ability to analyse and evaluate the information given as no rankings are made.

### Paper Recovery / Recycling

Both fresh forest fibre and recovered paper are used for paper production. Wood fibre can be recycled several times until it is worn down and damaged by processing. Although the fibre quality can be maintained during repeated recovery of the wood fibre, the raw material consumption and process residues increase. Paper recovery systems vary regionally and recovery rates are increasing (57% in Europe in 2003). Systems are normally coordinated within a country's waste management system to minimise paper in landfills and some subsidise collection. Recovered paper is now an international commodity with exports and imports to all world regions which is tending to level prices. Worldwide demand for recycled fibre in 2003 was 168 million tonnes, forecast to grow to 220 million by 2010.



1



2

*1- Mills close to forest regions provide the essential supply of fresh virgin fibre into the paper chain. Certified forest management ensure sustainable wood production whilst meeting relevant environmental criteria. Photo SCA.*

*2- Paper mills apply stringent monitoring measurement of effluent discharges. Photo SCA.*



## Pulp production

**Kraft** (or sulphate pulp) is used for producing fine paper and as reinforcement for some publication papers. Kraft pulp is made from wood chips cooked with chemicals that dissolve all substances except cellulose — about half of the total amount. Bleaching continues the dissolving process using chemicals to produce pure cellulose. Chlorine gas bleaching has caused some severe environmental problems but modern mills now use less harmful chlorine dioxide with low emissions (although some older mills may still emit relatively high amounts of chlorinated compounds). Totally Chlorine-Free (TCF) mills use oxygen, peroxide and ozone whilst ECF (Elemental Chlorine Free) has a very low chlorine level. Dissolved substances and chemicals are reclaimed by incineration in a soda recovery boiler that also produces steam for drying the pulp or paper and, often, electricity. Principal environmental effects: chlorinated compounds, emissions of oxygen-depleting substances, and air emissions of sulphur and nitrogen oxides.

**Mechanical pulp:** Wood is ground and most of it remains in the pulp. Mechanical pulp can be bleached to obtain certain visual properties. Principal environmental effects: quantity of electricity required and emissions of oxygen-depleting substances.

**Newsprint** is almost entirely based on mechanical and/or de-inked pulp. The wood fibre is suspended in water — less than 1% is fibre. The pulp is formed into a sheet where the water is removed by heat and pressure.

**SC** (Super-Calendered) is a mixture of mechanical and/or de-inked pulp, kraft pulp and filler — mostly fine clay combined with small amounts of other substances for certain paper properties. Production is similar to newsprint but the calendering uses high temperatures and pressures to give the paper its finish.

**LWC** (Light-Weight Coated) a base paper is made from mechanical pulp that is strengthened with some kraft. A coating is then applied and it is finished in a calender. The coating combines clay and ground marble with some additives to give desired properties.

**Fine paper** uses kraft pulp often combined with different kinds of fillers (clay, gypsum and starch). It may be coated in the same way as LWC.

**De-inked pulp:** Soap based chemicals release ink from magazines and newspapers and filtration removes metal and plastic elements. The cleaned fibre can then be used for paper production using less energy than for mechanical pulp production and less chemicals than for kraft pulp (all fibre has been subject to either process during its initial manufacture). Principal environmental effects: emissions of oxygen-depleting substances and handling of the sludge waste from the process.

### Transport & Energy generation

Transport is an environmental concern for society, both for emissions and road congestion. Paper production and distribution require significant transport of raw material to and from the mills. Ships are used for long-distance transport causing air emissions from engines. Trains are used where appropriate and their environmental effects depend on the energy used and its production. Road transport creates air emissions and road congestion. The paper industry was a large user of fossil fuels but now increasingly uses biofuels that emit no more carbon dioxide than the plants and trees consumed to begin with.

*The geography of paper supply indicates the most economically and environmentally efficient centres for virgin and recycled pulp and paper production. Mills close to forest regions provide the essential supply of fresh virgin fibre into the paper chain.*

*Most paper is consumed and collected in high-density population centres where it can be efficiently recycled into newsprint (< 100% recycled content) and some light weight coated and SC papers (with recycled content from 20%).*



*Modern flotation recycling plants can efficiently separate and process most post consumer paper waste including contaminants like glues, coatings and UV printing providing they are not in excessive quantities.  
Photo Ayelsford Newsprint.*

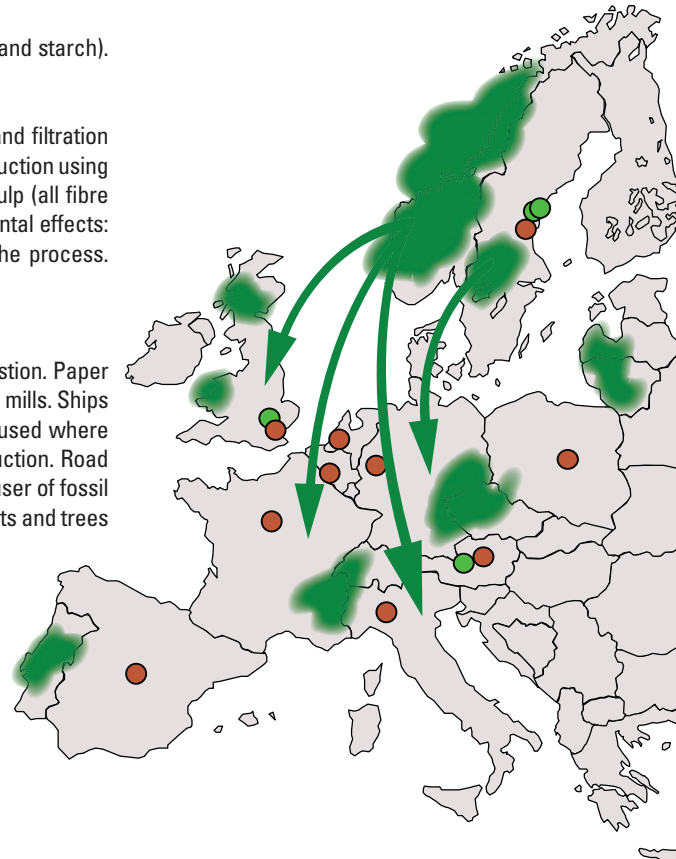

# The web offset environment

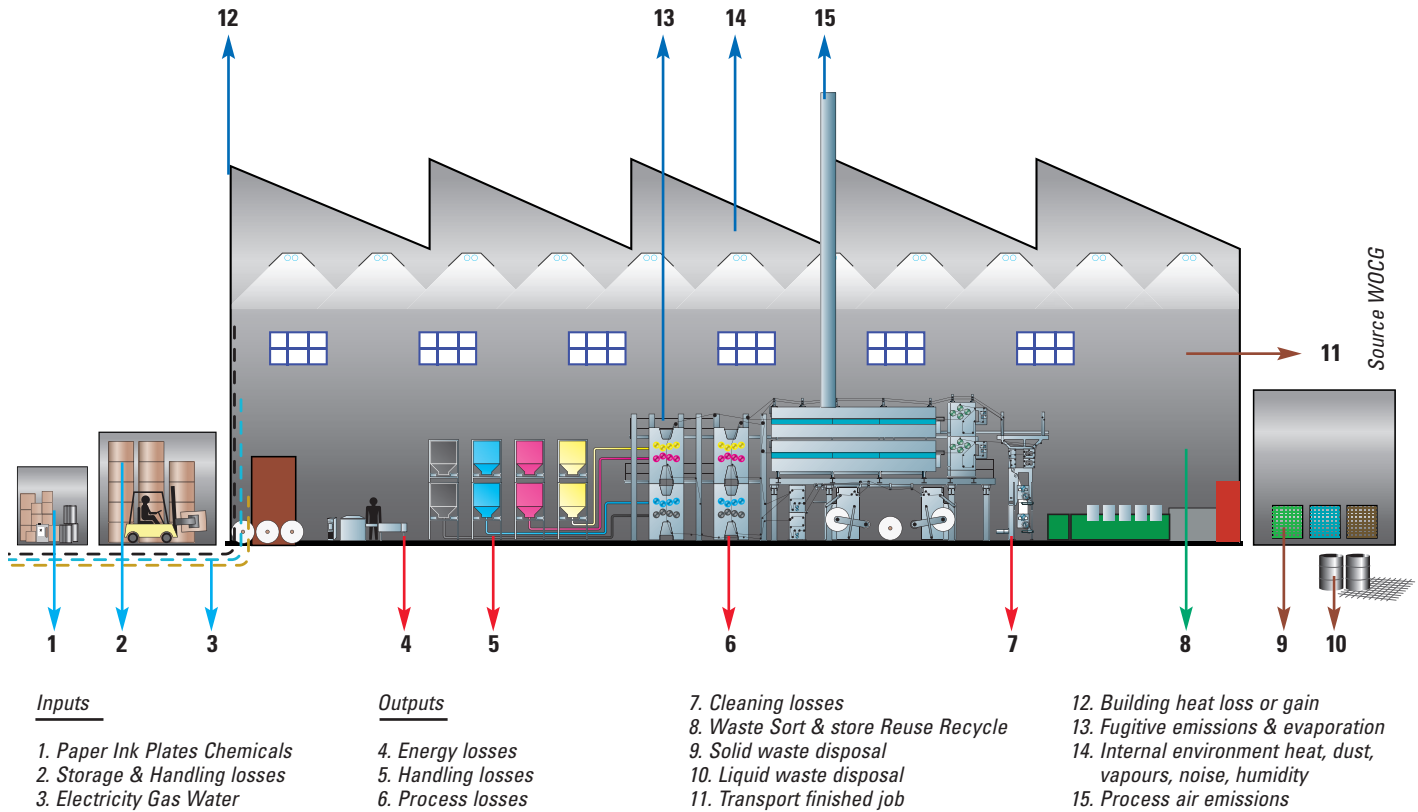

Optimising the physical production environment has a positive impact on the productivity of staff and machines and is appreciated by customers and neighbours.

- Minimise noise and air emission levels
- Optimum lighting environment
- Comfortable temperature and humidity suited to people and processes
- Housekeeping and cleanliness.

## Inputs and outputs

To improve efficiency, a printing company needs to identify what wastes are generated, and where. Materials are delivered to a printing plant and then leave it either as part of a finished job or as waste — less any components recycled, reused, consumed or lost in processing. Analysing this systemic process will identify opportunities to reduce, reuse, recycle, change (to alternatives) and, as a last resort, select the most appropriate disposal method. These flows comprise both individual processes and the plant as a whole. There are two complimentary approaches:

**Process:** Define each process stage in a flow diagram to identify inputs and outputs at each stage. Apply to each the 4-step questions of Redesign, Reduce, Reuse or Recycle to identify potential improvements.

**Plant:** Map on a site plan the process and materials flows of transport, storage, production and other areas. In each area identify economic and environmental impacts and where improvements can be made.

## Actions

**1 Inputs and outputs:** Define each process activity in a flow diagram.

**2 Environmental aspect:** Any part of an activity, product or service that impacts on the environment. Identify and prioritise for action the most significant aspects (those controlled by legislation, have the potential to cause demonstrable harm, or provide significant business benefits).

**3 Impact:** The effect of any change of an aspect (better or worse). Direct impacts are those over which there is control within the site. Indirect impacts are those that can be influenced upstream or downstream of the plant activities (choice of materials, energy, water utilities, waste disposal). Identify impact of improvement.

**4 Environmental action:** Redesign, Reuse, or Recycle to reduce negative impact. For each action estimate its economic and environmental benefit. Then how, who and when to implement the action, and how it will be measured.

Inputs	Operation	Outputs	Actions			Impacts	
			Reduce	Reuse	Recycle	Environment	Economic
Ideas, text and illustrations	<b>Premedia</b>						
Ink cartridges		Used ink cartridges			✓		▽
Blank paper		Used paper			✓		▽
	Digital artwork and scans						
	<b>Prepress</b>						
Data	Digital proofing on paper	Proof on paper	✓		✓		
Data	Digital soft proofing	No waste	✓				▽
Chemical storage	Imposition & RIP	Chemical storage & disposal	✓				
Plates	CTP plate Exposure	Storage & disposal of spoilt plates			✓		▽
Chemicals & water	Processing	Contaminated chemicals & water	✓				▽
Energy	Plate baking	Heat & other air emissions	✓				
Containers of consumable products	Fugitive emissions	Store & Dispose	✓	✓	✓		▽
	Plates & Proof						
	<b>Press Makeready &amp; Printing</b>						
Fresh water	Fugitive emissions, Noise & Dust	Contaminated water	✓	✓			▽
Dampening solution additives		Contaminated chemicals & water	✓	✓	✓		▽
Ink		Heatset air emissions	✓		✓		▽
		Waste ink	✓	✓	✓		▽
Wrapped paper rolls		Brown paper waste		✓	✓		▽
Paper		White waste	✓	✓	✓		▽
Paper		Printed waste	✓	✓	✓		▽
Pasting tabs and tapes		Splice and paper waste	✓	✓	✓		▽
Plates		Storage & disposal of used plates			✓		▽
Blankets		Disposal	✓				▽
Rollers		Disposal	✓				▽
Silicone			✓				▽
Adhesive inline glueing		Disposal of waste glue	✓				▽
Compressed air		Waste heat + Condensates	✓		✓		▽
Chilled water			✓				▽
Electricity & Gas (heatset)			✓		✓		▽
Strapping tape		Waste tape			✓		▽
Packaging & Pallets		Waste packing	✓	✓	✓		▽
Transport energy	Good printed copies	Fumes, Noise & Dust	✓				
Multiple cleaning solutions & Solvents		Dirty cleaning solutions & water	✓				▽
Cleaning cloths		Contaminated cloths	✓	✓			▽
Containers of consumable products		Storage & Dispose	✓	✓	✓		▽
	<b>Postpress</b>						
Remove strapping tape	Fugitive emissions, Noise & Dust	Dispose of waste tape			✓		▽
Perfect binding adhesives		Dispose of waste & container	✓				▽
Saddle-stitching wire		Dispose of empty drum		✓	✓		▽
Compressed air		Waste heat + Condensates			✓		▽
Electricity			✓				▽
Makeready & spoilt copies		Separate waste stream	✓		✓		▽
Trimming		Waste paper & Dust	✓		✓		▽
Containers of consumable products		Store & Dispose	✓	✓	✓		▽
Strapping tape		Waste tape			✓		▽
Packaging & Pallets		Waste packing	✓	✓	✓		▽
Transport energy	Saleable printed copies	Fumes, Noise & Dust	✓				▽
	<b>Infrastructure</b>						
	Fugitive emissions, Noise & Dust						
Containers of consumable products	Store	Storage & Dispose	✓	✓	✓		▽
Oils and grease	Store	Waste oil disposal	✓		✓		▽
Air and liquid filters	Store	Dispose of used filters			✓		
Spare parts	Store	Dispose of used parts	✓		✓		
Equipment & fittings		Disposal		✓	✓		▽
Lighting	Buildings	Used light fittings	✓				▽
Energy & Water	Heating Cooling of buildings		✓				
	Hot water for employees	Waste water					
	Process Heating & Cooling	Waste water & chemicals	✓	✓	✓		▽
	Employee facilities	Waste water & Consumer waste	✓				

Input and output of the web offset process system (digital workflow).

Examples of this and other work sheets can be downloaded (or identified) on the Champion Group's web site [www.wocg.info](http://www.wocg.info)

# Measure waste to control it



1

## 5 steps for successful waste minimisation:

1. Gather available information
2. Identify opportunities and prioritise
3. Make initial savings
4. Measure savings
5. Review to identify more savings

## 7 elements of waste:

1. Overproduction
2. Waiting
3. Transport
4. Inappropriate processing
5. Unnecessary inventory
6. Unnecessary motions
7. Defects.



2

1- Measure waste to control it. This printer is checking a sample of white slab off waste. Photo Quad/Graphics.

2- Keep work areas clean and tidy. Paper dust contaminates inks and plates if not adequately controlled. Minimise cleaning by reducing ink misting.

Waste is a good measure of plant efficiency. Some printers have a poor idea of their efficiency to convert paper into the final product and many only count the spoilage paid for by customers. Spoilage alone is not a good measure of overall plant efficiency because there are many other materials wasted in addition to paper. It is also essential to take into account unplanned waste from production errors in order to take action to minimise and eliminate them.

- Measure the weight of waste (not volume) because most waste is priced by weight.
- Ask the waste collector to supply reports of the weight of materials collected by type, or
- Install a low cost weighing scale (they do not need to be highly accurate).
- Prioritise what is measured beginning with the most costly waste sources.
- Use benchmarking to assess the comparative efficiency of waste rates.



## Minimise waste at source - Redesign or Reduce

The highest prevention priority is always reduction at source. This means selecting the optimum design, materials, processing, operating practices, maintenance and housekeeping consistent with the quality characteristics required of the finished product. The fundamental basis for a profitable manufacturing strategy is a design and manufacturing process that “does it right first time” to minimise waste from all sources, including re-working. Some areas to consider:

### 1 Is the print run length order optimised?

- Avoid over-runs “on the safe side” by using more accurate counters (laser counter at folder exit and stacker to count < 1 000 copies “forgotten” on the conveyor), optimise postpress waste copies. Create spoilage reduction teams to review the entire manufacturing process; often materials savings of 2-3% can be quickly achieved.
- Accurate waste gate drop at roll changes and blanket washing connected to the waste copy counter. Some printers use multiple waste diverting gates for white and printed waste.

### 2 Eliminate causes of machine stop-and-start that significantly increases waste — see BPG 4 “Productivity Maintenance”.

### 3 Is the workflow optimised to run press at optimum speed with minimum waste on the paper specified? See BPG 5 “How to get rapid colour OK.”

### 4 Evaluate new technologies that help optimise paper consumption.

### 5 “Do it right first time.” Improve planning and operator skills and use Standard Operating Procedures.

### 6 Maintain a top 20 list of waste errors to help avoid repeating them.

### 7 Keep work areas clean and tidy. Paper dust contaminates inks and plates if not adequately controlled — dust suppression methods include ventilation and fog misting (that also controls humidity and reduces electrostatic problems). Minimise cleaning by reducing ink misting.

## Optimise consumables

Offset is a chemically intense process with many opportunities to improve environmental performance. An optimum mix of consumables is critical to ensure productivity and reduce total running costs — the relationship between ink, paper, water, dampening solution, blankets, rollers and cleaning solutions is critical.

An example is a newspaper that had high ink misting causing deposits on the side frames, finger guards, path rollers and mist penetration into drive cabinets. Changing to different ink substantially reduced build-up on the press and the surrounding environment and consequently reduced the time, solvents and cloths used for cleaning. In addition, the life of return air filters was extended from 12 to 20 weeks, giving a further cost saving from the filters and the time required to replace them. Some consumables may be slightly more expensive to purchase but this is justifiable if they reduce total operating costs.



## Reduce packaging

Many countries have legislation that specifies the 3R principle to reduce packaging weight, volume, minimise hazardous substances and the environmental impact of disposal (e.g. EC Packaging and Packaging Waste Directive). A probable future trend will be to transfer the responsibility for industrial packaging disposal to suppliers. Actions to minimise waste include:

- A best practice strategy begins with a packaging waste audit.
- Discuss packaging with suppliers to negotiate better ways of delivering products and the



2



3



4

treatment of containers and associated recycling. It may make sense to reduce the number of suppliers for similar products to improve packaging efficiency.

- Can materials be delivered with less packaging by using alternate or return containers; increasing container size to reduce relative packaging volume; empty containers collected by their suppliers?
- Are there bulk delivery alternatives? These can often reduce purchase cost and simplify waste management.
- Can fluids be purchased in bulk with a system of smaller containers refilled on site and the bulk containers returned for re-use?
- Can suppliers packaging be reused within the plant or for distributing printed material?
- Make a preference for packaging materials that can be recycled and for which there is a demand.

Each company should analyse what is the best solution for them as local legislation and business practices are variable. Sometimes larger container sizes may not be appropriate if they increase the volume of dangerous products stored on site; if the impact of increased storage and handling issues are too high; and if it is contrary to Just-in-Time (JIT) policies.

## Separate and store waste

Separate waste to measure its volume; maximise its recycled value; minimise actual waste volume; and the cost of any residual disposal by incineration or landfill.

- Colour coded bins for different materials can be effective if staff are trained and motivated to use them.
- There are many different grades and prices for recycled papers. Separate them by grade and into printed and unprinted types. Some printers use multiple waste gates on their presses for white and printed waste and for different paper grades (see page 200).
- Dispose contaminated packaging materials by following the rules for the product that polluted it.
- Discuss with recycling companies, government agencies or others to identify the best recycling options.
- Regularly share recycling results with staff.
- Solvents (see page 196) and dangerous and hazardous waste (see page 198).

The environmental requirements for any form of waste may change during the life of a production facility.

1- The true cost of waste is like an iceberg with only a small proportion visible. Source WOCG

2- Colour coded bins can be effective to separate waste if staff are trained and motivated to use them. Source EcoConseil/FICG.

3- Use bulk containers whenever possible to minimise cleaning, transport and purchase costs. Photo Sun Chemical.

4- Transporting plates requires specialised packaging to protect them against transport damage and humidity. Protection of the plate's coating surface is provided by paper interleaving. CTP plate with automated loading systems has increased the demand for bulk wrapped plates as this uses fewer materials and reduces waste. Less manual handling of individual packs also lowers the risk of transport damage. Photo: Kodak GCG

# Volatile Organic Compounds (VOCs)



1



2



3

1- Select the right cleaning product for the right job. Source EcoConseil/FICG.

2- Remove the maximum amount of ink with a plastic spatula to avoid scratching steel rollers. Photo Sun Chemical.

3- A lint lifter absorbs a small amount of solvent and releases it during cleaning to effectively remove lint build-up and stubborn ink deposits on the rollers. Photo Sun Chemical.

Volatility	Class	Flash-point	Comments
High	A I	< 21°C	"Easily inflammable". Avoid use or limit to strict minimum.
Moderate	A II	21-55°C	"Inflammable" (OHS class below 39°C/100°F as flammable).
Low	A III	> 55°C	"Low inflammable" (OHS class 92°C/200°F as combustible).
			Use these where possible because they release almost no VOCs.

The flash/spark point is the temperature when an air-vapour mixture will ignite in the presence of a flame.

Many pressrooms have a typical odour resulting from the evaporation and spills from VOC containing products that mist and spread in the workplace. VOCs are commonly used in inks (see page 203), IPA dampening solutions (see page 204), cleaning products and some adhesives. VOCs are a large family of carbon-containing compounds of different types with varying safety, fire, health and environmental risks — most have some degree of toxicity. Legislation increasingly controls their use and many (but not all) are classified as dangerous. Solvents that are highly volatile at room temperature tend to have the highest risks and should not normally be used in web offset —abandon or minimise all classified as toxic.

Many printers have used simple best practice measures to reduce or eliminate VOCs. The benefits are cost reduction; minimised solvent consumption and VOC emissions; improved efficiency; and a better workplace.

## ⚠ Cleaning

One of the most significant environmental issues for printers is the high volume of cleaning products they use. Many commonly used products for cleaning blankets, rollers and ink systems contain highly volatile VOCs that are a major source of fugitive emissions and tend to be very wasteful as up to 50% of the solvent is lost by evaporation before cleaning work even starts. All cleaning activities generate waste from solvents, contaminated water, cleaning rags and soiled packaging that must all be correctly handled, stored and disposed of. Some are sources of air emissions and pose health, environmental and fire risks. Improved cleaning efficiency will reduce these impacts and lower costs.

- 1 Use cleaning solutions specific to the task and assess their impact on safety, health and the environment.
- 2 Correctly store cleaning products.
- 3 Minimise consumption by using best practice procedures.
- 4 Reduce the volume of solvent left in cleaning cloths.

## 🚫 Cleaning product selection

- Check the labels and MSDS (Material Safety Data Sheets) of the products used at your site to see what solvents you are using. Make a list of solvent-based products and identify alternatives with your suppliers.

- Where possible substitute solvents with the least harmful products. Vegetable Cleaning Agents (VCAs) are made from the esters of naturally occurring oils such as coconut and soybean and contain no VOCs. They use renewable resources; have low toxic and volatile levels (spark higher than 55°C). However, these agents are greasier than classic solvents and evaporate more slowly requiring careful wiping down at the end of cleaning (a greasy film residue may cause slippage of friction driven rubber rollers).

(Attention: Solvents containing vegetable-based terpenes are not recommended because of high irritation and allergy effects. Verify with manufacturers if a substitute cleaning agent is compatible with the equipment, rollers, blankets, etc. Inform, explain and train staff to understand and follow the user instructions.)

- Only use solvents for cleaning inks and oil; for other tasks use soap or detergent solutions. (Some detergent may have caustic or irritant effects and some concentrated products may provoke allergies.)
- If solvents cannot be substituted, then use a solvent with the lowest volatility possible.
- Only use aggressive solvents on a very limited basis - such as to remove hardened ink.
- Low volatile products (A III) are ideal for cleaning blankets and rollers, and works well with press wash-up systems.
- Clean metal parts with a slow evaporation solvent.
- Ink rollers require a slow evaporation solvent that must not evaporate before going through all rollers otherwise cleaning will be inadequate.

## Storage and handling

- Read and follow safety, health, storage and use instructions. Conform to regulations.
- Bulk solvent containers cut costs.
- Always use grounding and bonding straps when transferring solvents between containers. Avoid pouring solvents — use a pump to transfer solvent between containers.
- Keep solvents away from sources of heat and draughts. Volatility and incendiary risk increases with temperature — solvents are heavier than air and follow air currents to spread across large areas.
- Always keep containers closed to minimise evaporation. Use self-closing dispensers.
- Separately store ink containing soiled solvents in closed containers and correctly dispose of them.

## Cleaning procedures

- Train and supervise staff in best practice cleaning methods. Poor working procedures are one of the most significant causes of excessive solvent use.
- All solvents should be treated as potentially harmful and used with correct precautions to avoid contact with the skin or inhalation. Do not expose skin to cleaning products because they remove oils from the skin making it sensitive and it may become infected. Always use a good barrier cream, soap and moisturiser should as a part of cleaning best practice.
- Follow instructions for use: work in well-ventilated areas; wear protective clothing (splash proof goggles, coveralls that let no solvent through, appropriate gloves and face mask if needed).
- Schedule adequate time for regular cleaning. 'Clean as you go' to avoid build-up of dried ink, grease and paper dust.
- Clean the inking system when needed to avoid build-up of hard ink residues. Deglaze rollers and blankets regularly. The efficiency of automated roller and blanket cleaning systems depends on their correct maintenance.
- Remove the maximum amount of ink with a plastic spatula before cleaning with solvent.
- Use a lint lifter (scourers with a sponge inside) for more effective manual cleaning of rollers and blankets. This eliminates the use of multiple cleaning cloths and does not effect the blanket surface.
- Use dirty solvent for the initial washes — use clean solvent only for the last wash.
- Provide solvents as close to the press as possible to avoid carrying them long distances.
- Determine the optimum proportion of solvent/detergent to water effective for cleaning with the minimum wash volume. Premix these proportions using a mechanical mixer.
- Minimise excessive solvent application by using smaller size wiping cloths with spray bottles or plunger cans.

 Do not allow solvents to be used from an open can into which cleaning cloths are freely dipped. Do not put cleaning agents into empty drinking bottles or cans (high risk of accidental poisoning).

Do not use continuously running water or freely dispensed solvent to clean parts.

## Cleaning cloths (wipers)

- Reusable cleaning cloths are the most economic and more ecological solution because they reduce the high costs of dangerous waste disposal. Specialised laundry services exist in many countries.
- Use standard size cleaning cloths — not assorted sizes or rags.
- Solvent-containing cloth wipes should be kept in covered metal containers to avoid VOC emissions. Wring out excess solvent before placing in the container. Where permitted, use a centrifuge to recover solvent for reuse.
- Depending on solvent type used, the soiled cloths may be classed as dangerous goods for recycling — look for alternatives.

## Reuse, recycle, disposal

• Segregate different solvents. Assist reuse/recycling by avoiding large quantities of water in solvents.

• Recycle soiled solvents rather than treating them as liquid hazardous waste (their toxicity makes them unsuitable for discharge to sewerage, waters or land). A solvent recovery system recycles solvents for re-use for cleaning to reduce both costs of raw materials and disposal.

• Small quantities of mixed inks and solvents can be used for energy recovery

## Solvent recovery

"Used cleaning liquid" (solvent mixed with dirt, oil, ink and water) is normally treated as hazardous waste and disposed of by specialist companies for a fee. Recycling by distillation has been complex and often uneconomic for printers but more efficient systems are becoming available to recover solvents that will reduce purchase costs and disposal fees. Used washing agent (including water miscible agents) is recycled through separation and filtration to provide reusable washing agent and clarified wastewater that can be discharged into the sewage system. It is claimed that disposal costs of hazardous waste can be cut by up to 90% and fresh solvent purchase by up to 80%.

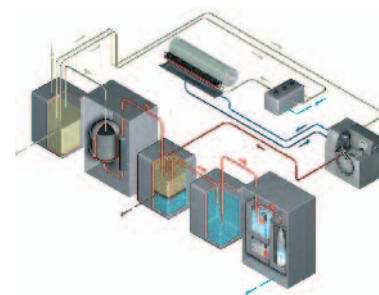

1

1- A solvent recovery system for brush operated blanket cleaning. Systems can be linked to the press blanket and roller washing units. Illustration Technotrans Ecoclean.

# Consumable materials



1

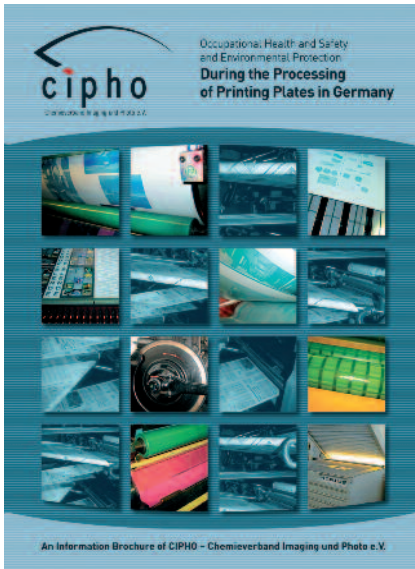

2

1- Small dispensing containers can help reduce excessive chemical use. Source EcoConseil/FICG.

2- CIPHO's "Occupational Health and Safety and Environmental Protection during the Processing of Printing Plates in Germany". This is an excellent reference and a guide to best practice in other areas and available in English and German. [www.cipho.de](http://www.cipho.de).

Materials storage conditions	Keep in	Storage	Sensitive to	Sensitive to	Max. storage
	packaging	position	UV & heat	Ozone	time/months
Paper	✓	On end	✓		6
Pasting tabs & tapes	✓	On side	✓		6
Blankets	Unroll	Flat < 14-high	✓	✓	6
Rollers	✓	Vertical	✓	✓	12
Plates	✓	Flat	✓	✓	12
Inks	✓		✓		3
Solvents	✓		✓		3-6
Plate & film developers	✓		✓		3-6
Chemicals	✓	Vertical	✓	✓	3-6
Aerosols	✓		✓	✓	
Optimum storage and operating environment	Temperature 20-25°C (68-77°F) Humidity 50-55% RH				

Suppliers' Material Safety Data Sheets indicate correct storage conditions to avoid hazards, deterioration and waste. Store all materials out of direct sunlight to avoid deterioration. Many consumables are sensitive to ozone and should be stored away from electrical apparatus. Use a 'first-in, first-out' policy to ensure that older materials are used first.

## ⚠ Dangerous and Hazardous substances

These are products that are potentially dangerous for health, safety and environmental reasons. They are defined by legislation and usually include solvents, ink residues, soiled containers of dampening solution and chemicals, aerosols, used oils, neon tubes etc. They are classed by categories (e.g. Harmful: acutely toxic; Toxic: can cause death; Irritant: affecting the eyes, respiratory system or skin). It is not sufficient to simply read the danger symbols; it is essential to read the label entirely and any accompanying Material Safety Data Sheets (MSDS) along with relevant statutory requirements that define conditions of use, storage, transport and disposal. Good practice is to abandon all products that are recognised as carcinogens; adequate substitutes are now available for offset printing. Some aspects to consider include:

## ☝ Product information & safe handling

- The supplier must provide relevant hazard warning labels on chemical containers. All product containers should be clearly labelled with the official classification of the substance.
- Display danger symbols prominently and prohibit smoking in the vicinity.
- Train staff how to manipulate, use and store hazardous products and that they understand the hazards and health risks (inhalation, skin and eye contact) described in the suppliers' Health & Safety Data sheets. These should be displayed in the area of use and kept up to date — caution with employees that may have literacy problems!
- Ensure that the correct personal protective equipment is available for handling of these materials.
- Implement accident prevention measures and safety procedures to deal with accidents and spillages.
- In case of spillage, clean up with absorbent material and keep the resulting waste separate for disposal.
- Keep containers closed when they are not in use to prevent fugitive losses of chemicals and solvents through evaporation or drying out. This reduces health and environmental risks and prevents contamination of the materials.
- For manual processing operations, use precise measuring techniques rather than estimating quantities to be added. Small dispensing containers help reduce excessive chemical use.
- Use protective wear specified (gloves and glasses) when handling dangerous products.
- Keep materials away from heat sources.

## ☝ Storage

- Ensure compliance with local and national statutory requirements for storage of hazardous materials.
- Use JIT to minimise stocks held on site. Only keep in the workplace quantities required for a day's work and store the containers on a pallet with retention.



- Store in a designated secure and separate area reserved exclusively for this use. It must be correctly ventilated and protected from heat; include a retention capacity sufficient for liquids stored; comply with specific fire regulations; and have safe electrical installations. Access should be restricted to personnel authorised for using the substances concerned.
- Maintain a register of the nature, quantity and location of the substances.
- Store products in their original containers with separate areas for incompatible products.
- Disposable cleaning cloths are hazardous. Re-useable cloths are hazardous only if not wrung out.
- Never mix hazardous and non-hazardous waste as this changes the profile of the waste.
- Waste from hazardous products must be collected and returned to secure storage in containers that are clearly marked with content.



### Disposal and Recycling

- Follow local and national disposal regulations and guidelines from the supplier.
- Hazardous waste can only be transported and disposed of by authorised companies. Retain a record of all shipments

## Water

Water has often been considered a low-cost resource with little financial incentive to improve the efficiency of its use. However, it is becoming a more expensive commodity to purchase, treat and dispose of, making reduction of consumption a production priority.

### Water quality

Water is a complex fluid that contains a little bit of practically everything it contacts — the air while falling as rain, the earth as it percolates into the ground, the piping as it is transported and all kinds of organic and inorganic matter. The quality of incoming water can be a source of production problems. Water hardness over 200 ppm of calcium can help form calcium soaps that prevent ink transfer and lead to stripping on ink rollers. Severe fluctuation of water supply conductivity may cause variations in dampening solution and ink interactions. Dissolved minerals (calcium, magnesium, iron and manganese) cause water hardness that can be treated by cation exchange. There are many water treatment processes available, such as distillation, softening, activated carbon, micro filtration, ultra- filtration, de-ionisation, reverse osmosis, etc.

### Production wastewater

Includes all water quantities directly used for the production of printing plates and printing products. Restrictions are increasing for direct discharge of wastewater from plate processing, used dampening solution and other contaminated water. Film and some CTP plate processing systems using silver halide are subject to strict wastewater disposal conditions. Do not discharge wastewater into septic tanks because they are not suitable to treat industrial waste. Regulations controlling wastewater discharge to storm water or sewer systems are highly variable and every industrial facility should check conditions for the discharge and monitor that they conform to load and concentration limits (economic and environmental risks).

**Platemaking:** In Europe, plate developer wastewater is classed as a dangerous waste that requires significant treatment prior to discharge — this is normally done by a specialised service company. Solvent based developer waste requires licensed disposal.

**Blanket and roller washes:** Most contain organic solvents and ink residues that cannot be discharged into sewers. Disposal to landfill is not permitted and can only be treated by a licensed disposal company.

**Dampening solutions:** IPA-containing solutions cannot normally be discharged into sewers. Sludge from cleaning is suitable for incineration.

**Cooling:** Wastewater from cooling towers may contain biocides or corrosion inhibitors and should not be discharged. Other cooling water may be discharged to the sewer system if local regulations permit.

### Water management

- Establish the volume and cost of the site's water input and discharge
- Audit water use and start a minimisation programme
- Improve metering (quantity) and monitoring (quality).
- Start a leak detection programme.
- Improve staff awareness and house-keeping and reduce process water waste. Reduce rinsing water to a minimum; do not allow cleaning under running taps.
- Improved cooling towers and systems; re-use cooling water; install air chillers.

### Other liquid waste

**Compressor Condensate:** Contains oil or grease and cannot be directly disposed into storm water drains. Condensate should either be collected by a licensed contractor, or disposed of into the sewer system after the removal of oil and grease if local regulations allow.

**Adhesives:** Non-soluble adhesives should not be discharged to sewer, but collected by a licensed contractor and disposed of at a licensed disposal facility. Water-based glues can be discharged to the sewerage system depending on local regulations.



1

1- The quality and consistency of incoming water can have a major impact on production. Photo Quad/Graphics.

# Consumable materials

## Paper



2



3

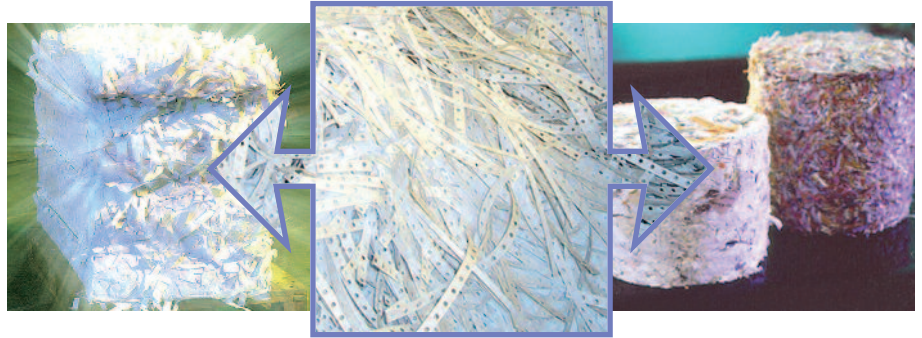

1

**Reduction of weight:** There has been a steady reduction in paper weight for newsprint. Some weekly magazines have reduced paper weight in countries like the US because of postal costs. However, these papers may be more expensive to purchase and more sensitive to production conditions (see Guide 3 “How to avoid surprises when changing paper grades”).

**Reduction of damage:** Storage, handling and roll preparation can be significant sources of paper waste, see Guide 1.3 “Roll to web processing”.

 **Recycling:** Papers should be sorted into the highest grades possible to achieve the best value for the recovered paper in the recycling chain. Sorting requires good internal cooperation from source departments and success factors include the effective separation of unlike materials and contamination control.

- **Damaged rolls of paper** (not returned to the paper mills) can be fixed into smaller usable rolls, or converted into wrapping paper.
- **Brown roll wrapping** the belly wrapper can be reused to separate layers of printed product; end caps can be reused to cap pallets of outgoing deliveries; any excess can be shredded and sent to a paper mill for recycling.
- **Cores:** can be shredded and either recycled or incinerated for energy.
- **White waste** (no ink, coating or, glue) from roll stripping at splice preparation, at web-up and core waste has a distinctly higher value than printed waste.
- **Printed waste** separate and bale by grade to maximise its value. Keep separate coated and varnished waste and jobs with very high background tint ink coverage (e.g. directories).
- **Office paper** has a comparatively high value for recycling into other products — treat used office paper as a separate recycling grade.
- **Paper cartons from suppliers** can be reused for packaging printed material or recycled in a similar manner to paper recycling — keep a separate grade.

### Why use recyclable pasting tapes?

Recyclable tapes and liners are an increasingly important environmental best practice because conventional pressure sensitive adhesives (PSA) and silicone-coated release liners can contaminate the paper waste stream. Conventional PSA glues are also a major source of office waste paper contamination. PSA manufacturers can provide tapes with enhanced adhesive recyclability using techniques for both water soluble and high strength products that can be removed from the pulp. Many tapes have been developed to satisfy splice quality, production rates and recycling for which there are three critical quality-performance aspects:

- 1 Selection of the appropriate tape for the task;
- 2 Correct procedures for handling, storage and application to ensure all the intended performance benefits are obtained;
- 3 Tape manufacturer that ensures consistent quality. Check with your supplier to ensure that their PSA tape is “recyclable” according to the TAPPI test method (UM213A).

1- Separate and bale waste paper to maximise its value.

2- The brown roll “belly” wrapper can be reused to separate layers of printed product. Photo Quad/graphics.

3- Separate printed waste from white waste (no ink, coating or, glue). Photo Quad/graphics.

## Other solid waste

**Plastics:** The availability and conditions for plastic recycling are highly variable and these should be assessed. Separate plastics into different classes for a higher value recycling.

- **PETE strapping:** Bale used strapping (in the same way as recovered paper) or granulate it (cut into small pieces) for sale to either the manufacturer or a certified recycler.
- **ABS and PS plastic spools:** Primarily from postpress stitching operations. Sort spools by grade and sell them to a scrap plastic recycler.
- **LDPE plastic stretch film:** Stretch film can be collected and baled in-house and sent to a recycler or broker.
- Clean plastic containers that are not recyclable should be placed in the general industrial waste stream.



**Empty chemical and ink containers:** May be classified as hazardous waste (depending on their original content) and have variable legal requirements for their disposal. They should be treated as having the same hazard as the chemical they originally contained. Store these containers in a secure area before either returning them to the supplier for reuse or sending them to a recycler. Consider changing to larger reusable bulk containers to reduce quantity of containers requiring disposal.

**Wood:** Pallets should be reused or returned to the supplier wherever possible. Damaged wooden pallets can be sent to pallet recyclers to either repair them, or dismantle the components to assemble new pallets and shred any remaining waste for landscape mulch, boiler fuel, etc. Scrap wood, crates and machinery pallets can be offered to employees for personal use. Remaining scrap should be disposed of by a wood recycler.

**Lead acid batteries:** All batteries should be collected and stored separately for recycling.

**e-cycling:** The EPA estimates that over 2 million tons of used electronics are disposed of each year in the USA. All used electronics (telephones, televisions, printers, computers) contain heavy metals that can cause serious environmental damage. Many communities ban electronics from landfills where these metals can dissolve and seep out to contaminate ground and water supplies. Before recycling old electronics, find out if someone else can use them — particularly non-profit organisations. If not, then dispose of it through an e-cycling programme or business where they can be either refurbished or deconstructed so the components can be reused or recycled.

**Mercury-containing products:** Fluorescent lighting tubes, thermostats, etc should be collected for recycling.

## Solid waste for disposal

The analysis of each activity that generates solid waste can lead to process changes, reduction, new recycling programmes and improved management of residual waste.

- Track and record disposal activities in an electronic database (location, date, type of container, weight and disposal cost). Analyse trends to identify if changes are required for pick-up scheduling, or reinforcement of reuse/recycling programs
- Review if available container volume/weight capacity is being used efficiently. Ideally containers should only be removed when full and not on predetermined schedule because the same price is paid to remove a full or partially full container.
- Adapt collection schedules to ensure space in containers is utilised as close to capacity as possible.
- Compactors provide the high utilisation of volume/weight and electronic sensors can be used to monitor pressures and automatically call for container collection.

Final solid waste disposal is either by incineration or landfill. Contract management of waste transport and disposal should ensure that each systematically identifies locations, site descriptions, site life, insurance coverage and any other information for legal compliance.



2

1- Review if available container capacity is being used efficiently. Source EcoConseil/FICG.

2- Ensure the right selection and use of systems that extract, compact and bale paper to prepare it for transport to recycling mills. Photo Hunkeler.

# Production process



1



2

1- CIPHO's "Occupational Health and Safety and Environmental Protection during the Processing of Printing Plates in Germany". This is an excellent reference and a guide to best practice in other areas and available in English and German. [www.cipho.de](http://www.cipho.de).

2- Plate processor cleaning system using a new filter-less cleaning procedure using centrifugal forces within a rotating drum.  
Photo: Technotrans Spinclean CTP.



The Matchprint Virtual Proofing System LCD recently earned SWOP certification to deliver accurate RGB monitor viewing of CMYK colour reproduction that reliably predicts final printed results. Photo KPG.

## Proofing

**Reduction:** Certified colour-critical "soft" proofing systems can eliminate physical proofs and their related delivery, time, consumables and disposal costs. They are particularly suitable for publication printing when combined with closed-loop colour control systems to 'print by numbers'. 'Soft' proofing systems with approved off-the-shelf LCD monitors offer proofing over the Internet irrespective of time or location.

## Plates & Processing

Different plate and chemistry systems often have very different chemical formulations and environmental impacts. It is therefore essential to follow chemistry handling, storage and disposal guidelines from the supplier and to comply with local regulations (see CIPHO guide).

**Reduction:** New technologies have significantly reduced the environmental impact of prepress. Conventional negative plate processing changed from solvent to aqueous-based development in the 1980s. CTP plate then eliminated the film step delivering a significant reduction in pre-press processing chemicals. However, different CTP plate technologies have different environmental impacts and other characteristics:

- **CTP plate silver:** The first CTP plate technology, it continues to use chemicals similar to film processing and generates silver liquid waste. It is the least environmentally friendly CTP system because it requires greater volumes of developer; and the wastewater requires controlled disposal with neutralisation and silver recovery.
- **CTP plate photopolymer (violet) and CTP plate thermal:** Both systems are much more environmentally friendly but still as a general rule require controlled disposal of chemicals and in some cases this includes wastewater (high pH and solids content require neutralisation and/or filtration). Ablation systems require air filtering.
- **CTP plate thermal 'on press' development:** New generation of virtually process-free plates. Where the non-image area coating is removed on the press when it comes into contact with the inking and dampening rollers. This emerging technology eliminates plate chemicals and wastewater, however, it is not yet suitable for all applications where CTP plate is currently used.

Plate processor cleaning and filtering systems are available that are claimed to significantly extend developer life. Operational savings are related to the volume of plates used and the reduced replenishment of fresh developer. However, not all plate-developer systems are suitable for these systems; and some only work effectively in continuous 24/7 production. It is recommended that the relevant suppliers are consulted to ensure compatibility and to calculate an ROI on the plant's specific operating characteristics.

**Recycling:** The aluminium base used for offset printing plates is recyclable.

# Inks

**Heatset:** Heatset inks are solvent-based but few VOCs are released from open ink containers or ducts at ambient temperatures. Around 80% of the ink solvents are evaporated during drying and the remainder is absorbed by the paper. The energy released from heatset ink solvents is reused in the drying-oxidising process that also controls atmospheric emissions).

**Coldset inks:** Solvent-based coldset inks release around 5% VOCs into the atmosphere during printing and should be used in well-ventilated areas. Vegetable oil-based coldset inks made from renewable resources (soya in the US and rapeseed in Europe) contain lower levels of VOCs and are used for around 20-30% of the content of coloured inks where the pigment has the greatest cost impact. However, these formulations are less economic with black because the cost of the ink is much more influenced by the cost of the oils. Pressure from the US agricultural lobby has resulted in soya beans being widely used for coldset colours — the 'soya seal' denote inks with 30% or more soya content. In Europe, there is no clear content requirement and most inks are now a hybrid of vegetable and mineral-based oils combining the best properties of each. Wholly vegetable inks are slightly more expensive and offer little or no technical advantage; and their environmental performance relating to CO<sub>2</sub> produced in processing is debatable.

**Waterless:** The elimination of certain ink ingredients and the absence of dampening solution provides theoretical printing and environmental advantages; on the other hand, they contain more VOCs than conventional inks and tend to require more frequent blanket washing. After nearly 30 years these inks have had only limited success in web offset.

**Ultraviolet (UV):** These inks and coatings contain no traditional solvents. However, there is only limited web offset use of UV, principally because of their higher comparative ink cost. The main web offset use of UV is for coating.

## Best practices

- Store ink correctly to avoid degradation and waste (closed containers out of sunlight).
- Use a densitometer or closed loop colour control to eliminate overinking — this usually reduces ink use by around 15%, ensures an optimum printed result and reduces press cleaning.
- Use pumping systems to prevent ink waste and spills. They also reduce accident risk.
- Use bulk containers whenever possible to minimise cleaning, transport and purchase costs.
- Vegetable inks for coldset colours reduce solvent consumption.
- Keep old inks in a pumpable state and segregate them from other waste (no cloths; incompatible chemicals; blanket wash water; water soluble alcohol-based solvents; or excess water).
- Unwanted bulk inks can be reblended if they are not contaminated.
- Most inks can be recycled. Residues of different coloured inks may be blended into black ink.
- Ink filters and their polypropylene bags can be recycled into energy at co-generation electrical plants.

## Disposal

Most offset inks contain about 20% organic pigments that are insoluble and not easily biodegradable. Offset inks are not generally classified as dangerous since suppliers have eliminated hazardous and polluting (HAP) ingredients like heavy metals (European ink suppliers have agreed to exclude certain dangerous components that are toxic or contain heavy metals and certain organic colourants). However, undried inks are classified as dangerous waste in many countries, and can only be disposed of under controlled conditions. Incineration (fuel blending) is the most suitable disposal method because ink has a calorific value higher than coal.

Solvent-based dispersion coatings and varnishes should be collected by a licensed contractor and disposed of at a qualified treatment facility. Water-based dispersion coatings may be discharged to sewer depending on local authority requirements. Residual solvent-based varnish is highly flammable and needs to be treated accordingly.

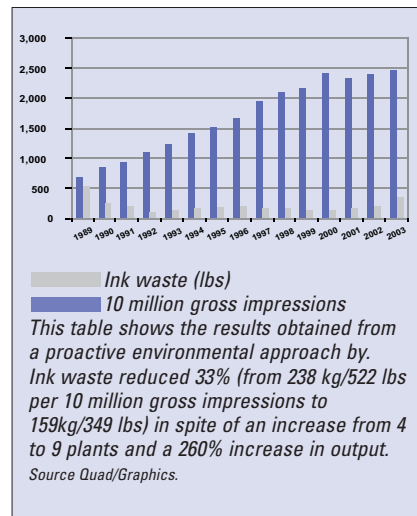

1

*1- Use the largest ink containers whenever possible to minimise cleaning, transport and purchase costs. Delivery systems available include drums, containers, fluid bags, above ground and below ground tanks for tanker refilling. In some cases, secondary containers may be required to limit leaks and spills.*

*Photos Sun Chemical.*

# Dampening



1

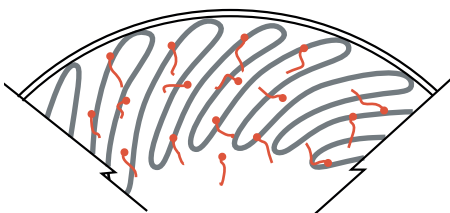

2



3

**1-** Dampening solutions are a varying cocktail of water and multiple additives containing traces from cleaning solvents, inks, blankets, plates and paper. Source WCOG.

**2-** A patented laid-over pleat geometry filter maximises the dirt holding capacity of the filter by up to three times that of a uniform pore structured filter element. The graded pore structure has several outer pre-filter layers that get progressively finer towards the control layer. Source Pall Lithopure™.

**3-** A new filter design with an increased surface area is claimed to provide 3 to 6 times longer filter life and 2 to 4 times longer dampening solution lifetime. Photo Technotrans softflow.

**4-** Successful alcohol reduction requires accurate control. Contact-free infra red measurement of the gas above the solution is not effected by dampening solution contamination and is reliable for measurement of 0 - 15% ± 0,5% (volume measurement has unacceptable ± 20% error). Photo Technotrans AZR.

Most dampening solutions are a varying cocktail of water (treated or not) and additives (acid, gum Arabic, softeners, desensitisers, biocides, surfactants and IPA or a substitute); the solution also carries traces from cleaning solvents, inks, blankets, plates and paper. These substances are not all easily biodegradable and some are potentially dangerous for the environment if discharged into mains water drainage and are therefore subject to increasing regulation. (A preliminary analysis of 20 sheetfed and heatset dampening solutions in France shows high levels of toxicity and too many organic compounds to be safely disposed in sewage systems without having consequences on wastewater treatment plants and the environment.) Certain additives may contain toxic products that should not normally be used in the printing industry because adequate substitutes are available.

 A multi-step approach is recommended to improve printing and environmental performance of dampening systems:

1. Ensure that incoming water is of a consistent and suitable quality.
2. Reduce, or eliminate, IPA (if used).
3. Extend dampening solution lifetime.

## 1. Water quality

The quality and consistency of incoming water can be a source of dampening problems. Severe fluctuation of water supply conductivity may cause variations in dampening solution and ink interactions; water hardness over 200 ppm of calcium can help form calcium soaps that prevent ink transfer and lead to stripping on ink rollers. Reverse osmosis is a frequent solution for treating hard water or variable quality. It filters out 99% of salts, micro-organisms and chlorine and is particularly helpful when reducing IPA in dampening solutions.

## 2. Reduce, or eliminate, IPA

Alcohol is still frequently used to improve wetting of the solution but it is a major source of fugitive VOC emissions that are health, environmental and fire hazards. It is also expensive, particularly as up to 50% of IPA evaporates from mostly uncovered founts. IPA-based solutions cannot be discharged to sewer. IPA reduction or elimination provides an intermediate environmental and economic benefit because it is a high cost petroleum derivative. "Reducing IPA use: Industry examples" Environwise UK. The results of two web offset printers demonstrate the economic advantages of eliminating IPA from around 8% to 0%. Printer A operates 7 heatset webs and now saves annually E 405 000 with VOC emissions reduced by 385 tonnes/year, eliminating 488 000 litres/year of IPA; Printer B with 6 webs saves E 86 000 with 142 tonnes less emissions and has eliminated 180 000 litres/year.

Strong regulation in the US helped eliminate IPA in heatset and most printers in Britain, France and Scandinavian have successfully converted to low- or no-IPA use. The keys for successful elimination of IPA are the close co-operation with the printers who need to adapt to a more sensitive settings; assistance from suppliers; and choosing the right (and non-dangerous) additive to substitute IPA. Alcohol replacement chemistry usually requires no capital investment and uses small volumes of glycols or glycol ethers along with some other additives like surfactants.



4

### Reduce IPA levels & alcohol-free substitutes

- Dampening refrigeration system to maintain solution < 12°C to limit evaporation.
- Very accurate automatic dosing system,
- Consistent incoming water supply for dampening water.
- Correct roller and dampening settings.
- Good process management.

### Change to IPA-free.

- Substitutes are widely available and suppliers can assist in the operational adjustments that may be required to use them effectively and avoid creating other problems.
- Generally, the operating range of substitutes is smaller and viscosity may vary with different temperatures leading to inconsistent wetting.
- Pre-treatment of water can help IPA reduction and substitution (reverse osmosis, ions resin exchange).
- Rubber rollers with different hardness and solvent resistance may be needed to meter IPA-free dampening solution.

## 3. Extend dampening solution lifetime

A stable printing environment requires the dampening system to be adequately cleaned to remove contaminants from the solution. High printing speeds, reduced IPA content and lower quality paper can cause massive contamination of dampening circulation systems. This can increase operating costs through more frequent replacement of the solution, intensive cleaning and machine down time. Reducing the frequency of changing the solution and cleaning the system has high potential for economic and environmental gains provided it minimises plate scumming, image tinting, 'hickeys' and maintains conductivity.

- Biological contamination is a major issue, in particular for IPA-free solutions. The dampening solution provides algae with perfect growing conditions of warm, oxygenated water that contains nourishing paper fibres. There are now stricter controls on what biocides can be used — the current types are more environmentally friendly but weaker. The alternating use of different biocide products helps prevent algae adapting to them.
- It is recommended to control and adjust the conductivity daily to maximise dampening solution life.
- New long-life filters and filter-less cleaning systems can significantly increase dampening solution lifetime to reduce costs, increase efficiency and be more environmentally friendly. The total cost of alternative cleaning methods should be assessed against current practice including all related costs (dampening additives, waste disposal, filter, maintenance down time, frequency of change).

New filter designs not only last much longer (than standard products) but also substantially extend the dampening solution's lifetime. Filters can be placed either inside the recirculating tank or as canister assemblies (that can be retro-fitted). (NOTE: To ensure that dampening solution flow is not interrupted and the filter and press are protected from excessive pressure damage a continuous flow valve must be added inline of the filter element in a recirculation tank in case the filter becomes blocked.)

A filter-less centrifugal system can also extend dampening solutions lifetime by continuously separating the different densities of water and contaminants (oil and solids). The oil sludge continuously discharges into a container whilst the separated solid matter stays inside a plate type drum that is periodically manually removed as a solid cake. Continuous circulation of the entire dampening solution volume in the by-pass connection ensures efficient cleaning — the by-pass line operates without affecting the actual dampening solution circuit.



1



2

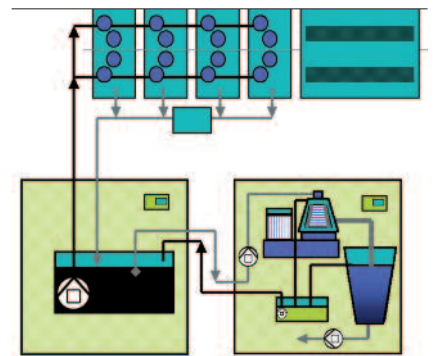

3

*1- If a swimming pool was treated like a dampening system, it would be emptied every other week, all the water and chemicals would be 'thrown' away then everything would be thoroughly cleaned, before completely re-filling it with fresh water and adding new chemicals.*

*Source WOCG*

*2- Control and adjust the conductivity daily to maximise fountain solution life.*

*Photo Sun Chemical.*

*3- A centrifuge can separate the different densities of water and contaminants without any consumable filters. It is connected in by-pass to the circulator tank and contaminated solution is pumped into a separator. After cleaning the dampening solution returns (via an intermediate tank) to the circulator.*

*Photo Technotrans Spinclean.*

# Blankets & washing systems



Cleaning solution: preferably use low volatile products for blanket cleaning.



Safety measurement in heatset dryers is based on low-explosive solvent types that have significantly reduced explosion risk. There is only a risk if an operator interferes - manual spraying of solvents on to the blankets is strictly prohibited because of risk of dryer explosion.



Automatic blanket washing, optimum programme selection helps minimise cleaning materials and waste, e.g.:

1. Pre-dampening of blankets before "impression on".
2. Start-up wash after a press-stop when there is low residue on blankets.
3. Crawl wash cleaning at web-up speed.
4. Production wash-up "impression on" at reduced or maximum speed.
5. Production wash-up "impression off" before "impression on" at reduced press speed.
6. Delivery wash-up during braking of the press, inking-dampening forme rollers and impression cylinder are "off".
7. Final wash-up without web when production is complete.
8. Quick start-up washing programmed into start-up sequence.

Automatic cleaning characteristics	Cloth system	Brush system
Solvent application	Evenly solvent application across cylinder width	Solvent quantity can be adjusted
Solvent quantity control	Available on some models	Yes, to control cleaning quality
Relative consumption of solvent	Can be less than brush	About the same, but can be recycled
Other consumables cost	Cleaning cloth	None
Solvent misting - general	None	Print contamination risk if not well adjusted
Solvent misting - part web widths	None	Print contamination risk
Waste treatment	Disposal of cloth	Treatment of solvent
Maintenance	Time to change cloth	Cleaning drip tray
Comparative cleaning result	Good	Good- high dirt absorption of brushes

## Blanket washing

Blanket washing is a major user of solvents. Automatic washing systems provide economic and environmental benefits: faster cleaning, less washing solution/cloths per cleaning cycle, lower solvent evaporation and improved working conditions. The two contact systems use either a cloth or a brush for cleaning and the environmental impact of each is different. The cleaning solvent used by brush can be recycled. Cloth systems use less solvent but the disposal of used cloth has an environmental impact. Cleaning times are similar for both systems and the length depends on the extent of contamination. Shorter washing times reduce printed waste. Recommended heatset production washing cycle is 8-10 seconds at each roll change and 30-40 seconds at the 4th roll change for the dryer to regain its balance. Some printers running light weight coated papers with high ink coverage have found that tack-out web breaks may be reduced by washing units in the reverse order (e.g. from yellow backwards to black).

Web cleaning systems can be installed between the paster and the printing unit to remove dust and debris before the web enters the printing unit. Some newspaper printers report a reduction of blanket washing intervals but blankets still need to be cleaned when changing to new jobs. Some printers are installing combination web and blanket cleaning systems to minimise blanket wash frequency.

## Blankets

Blanket cleaning adds a residue of ink, solvents and VOCs that builds up within the blanket throughout its life. The result is that used blankets are unsuitable for recycling and they can only be disposed of by landfill or incineration. Traditional blankets are ecologically unfriendly because of their manufacturing process and materials. For 40 years, all blankets have had a similar structure of a cotton canvas carcass laminated with elastomers, a compressible layer and an elastomer surface).

These negative issues have led to the development of a completely new blanket construction that better responds to the environment whilst providing equal or improved printing efficiency. One example uses synthetic fibres and formulated polymers to replace the cotton canvas and rubber. The polymer based carcass and printing surface reduces solvent consumption during manufacturing by 70%, and allows the polymers to be recycled. Print production experience on heatset, coldset and sheetfed presses shows that this technology equals or exceeds the highest print quality from traditional blankets with better ink transfer that reduces ink and dampening solution settings. In addition, the polymer structure does not absorb washing solvents and none penetrate the carcass through the edges. The increased printing life reduces the number of blankets to be purchased and disposed of. They are also easier to clean because the surface is more water receptive to increases transfer efficiency and reduce debris build-up — leading to a claimed 25% reduction in cleaning cycles that reduces blanket wash consumption and paper waste.

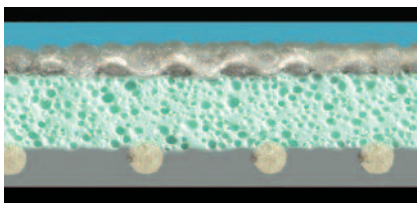
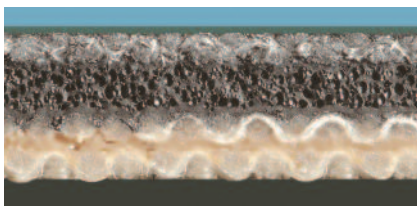

Traditional blanket construction (upper) is environmentally unfriendly. New blanket technology, such as the Stabil-X (lower) reduce solvents used in manufacturing and can last twice as long on press.

Photos: Trelleborg Printing Solutions.



# Air emissions

At one time, heatset process emissions were directly exhausted into the atmosphere resulting in a visible smoke plume and odours. These emissions contributed to public health problems including the formation of ground level ozone that, together with NO<sub>x</sub>, is a precursor for the formation of photochemical smog. Even low ozone concentrations at ground level can cause serious damage to plants, animals, buildings and plastics and is a breathing irritant. As a result, governments have made laws to protect public health and the environment. These began in the US in 1970 with the creation of the Environmental Protection Agency (EPA) and the Clean Air Act, which have been progressively strengthened and replicated worldwide.

Today, process exhaust streams must meet strict regulations to reduce chemical emissions. Chemical compounds regulated by law include evaporated solvents (VOC), carbon monoxide (CO), nitrogen oxides (NO<sub>x</sub>), particulates and sulphur oxides. These noxious gases originate from high temperature combustion and incomplete combustion from motor vehicles, power stations and industrial exhaust streams. Common VOCs found in industry today usually start out as either fractions of crude oil or synthesized products from the petrochemical industry.

## VOC + NO<sub>x</sub> + UV = Ozone

Ozone from industrial and other emissions is the same substance that we talk about when we discuss the destruction of the ozone layer — the difference is a matter of 25 to 50 km vertically.

Ozone at ground level is a toxic gas that can affect our breathing. Ozone in the stratosphere is beneficial because it absorbs and blocks out cancer-causing ultraviolet radiation from the sun. Although the substances are the same, they are the result of two different chemical processes each having different consequences.

Ozone at ground level is manufactured on a daily cycle:

- 1 Some levels of VOCs and NO<sub>x</sub> from industrial and other sources exist in the atmosphere at all times. The concentration of VOC and NO<sub>x</sub> increases significantly during peak motor vehicle use.
- 2 From sun rise to sunset the ultra violet light converts these chemicals into ozone.
- 3 Ozone production stops with nightfall and the ozone slowly decomposes until the cycle begins again the next day.

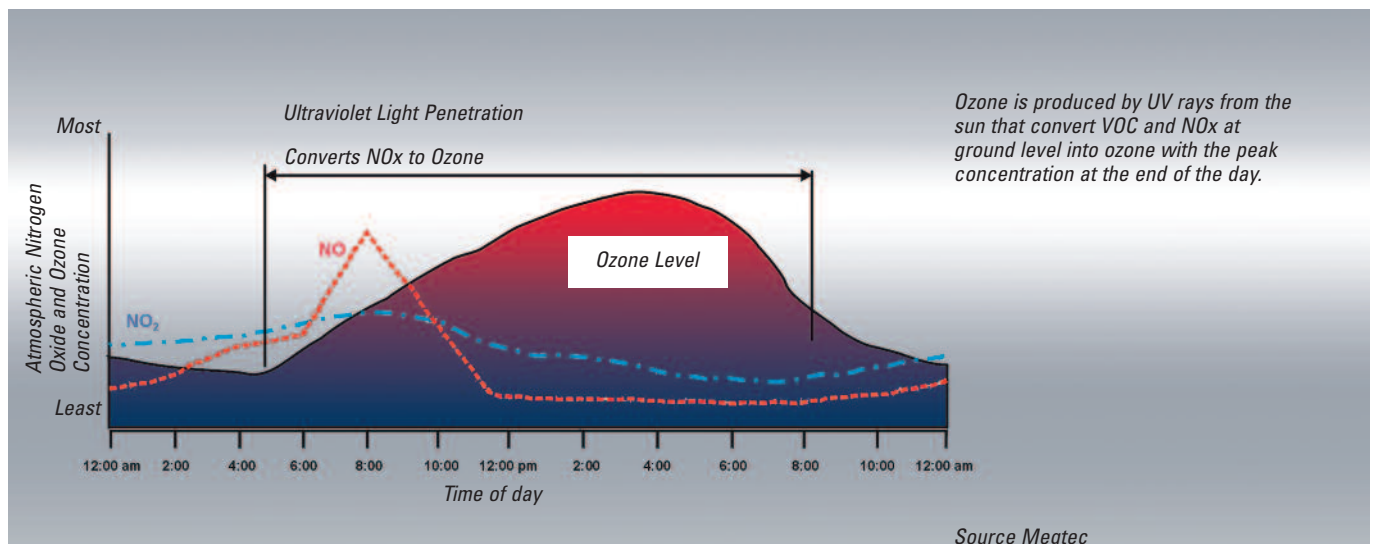

Chart recorder monitors oxidiser combustion chamber temperature to indicate CO and VOC destruction.

Photo MEGTEC.

## Oxidiser measurement

**Chart recorder:** Commonly used in the UK to monitor oxidiser operation. In the US, temperature recording is mandatory to show compliance with permit conditions. This is the primary indicator of VOC destruction. This relatively simple method records the oxidiser combustion chamber temperature when the press is running. There is a strong relationship between the combustion chamber temperature and CO destruction. Electronic chart recorders are becoming more popular to reduce paper charts and improve record keeping.

**Stack tests:** The test measures the efficiency of capture and destruction efficiency of the installation by monitoring the airflow and VOCs into the exhaust.

# Air emissions

## Air emission compliance principles

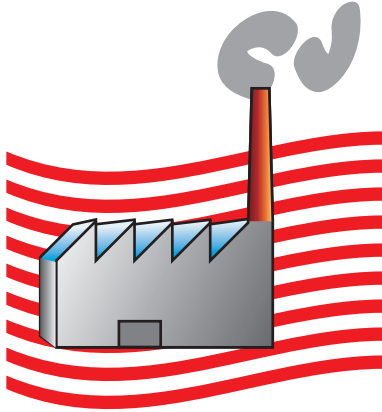

1

Air quality directly affects quality of life and most countries have pollution control regulations to protect public health and the environment. However, the control levels and measurement of air pollution is variable not only between countries but also between different areas in the same country. Compliance levels may be determined and enforced either nationally or locally. In some regions, 'best available technology' legislation may reduce the minimum compliance levels below those currently in force as more efficient technologies become available. Due to highly variable legislation it is essential that printers carefully check the control regulations in force at their site(s).

**EPA US Clean Air Act:** The National Ambient Air Quality Standards sets levels for six major air pollutants: ozone (O<sub>3</sub>), particulate matter (PM), carbon monoxide (CO), sulphur dioxide (SO<sub>2</sub>), nitrogen oxides (NO<sub>x</sub>), and lead (Pb). The majority of these have been developed to address those sources that contribute the highest levels and would not apply to a heatset web offset printer directly. New Ozone (O<sub>3</sub>) designations may impact new installations that emit VOCs. US regulations define that distillates components of heatset inks will be deemed to be VOCs by testing the ink. VOC levels of removal are based on regional or local ozone levels and are determined by State or other designated authorities.

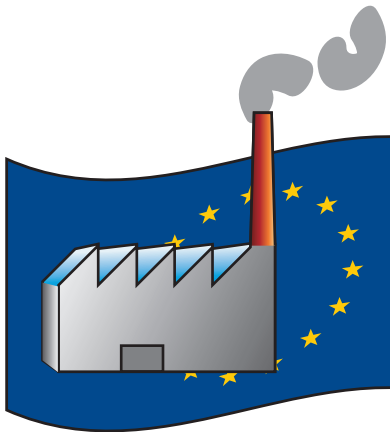

2

**Europe:** EC directive VOC 99/13/EC 1999 limits solvent emissions into the atmosphere and requires a management plan for them — including fugitive emissions (through doors and windows) that are not captured and treated. Heatset levels for VOCs are set at 15-20 mg/Nm<sup>3</sup> (varies by country), Carbon monoxide CO 50 mg/Nm<sup>3</sup>, Nitrogen oxide NO<sub>x</sub> 50 mg/Nm<sup>3</sup> at oxidiser exit and fugitive emissions are set as a % of annual solvent consumption. Heatset inks are classified as a VOC in the EC when they are in the dryer (but not when they are at room temperature); emission control is based on the performance of the oxidisers and regulations vary depending on site size, location, products and local regulations. For coldset, fugitive emissions of 20% are normally allowable.

## Emission control technologies

Web offset pollution control technologies were originally add-on units such as afterburners that cleaned emissions at the expense of additional investment and energy consumption. The underlying trend during the last 10 years has been to integrate thermal oxidation with the drying process to reduce overall energy costs, improve clean-up performance and minimise capital and installation costs. The two principal oxidation processes used in web offset are Thermal Recuperative, and Regenerative Thermal Oxidation (RTO).

Thermal oxidisers convert hydrocarbons into carbon dioxide (CO<sub>2</sub>) and water (H<sub>2</sub>O) through the process of oxidation, which raises the temperature of the process exhaust to break the hydrogen carbon bonds and create new bonds of CO<sub>2</sub> and H<sub>2</sub>O. Heat is released when these new bonds are formed (exothermic reaction). The efficient destruction of VOC is determined by three interdependent factors — time, temperature, turbulence — that must be optimised for a thermal oxidiser to achieve high destruction efficiency.

- **Temperature:** The bonds between carbon, hydrogen, and oxygen are broken more easily at high temperatures. Hydrocarbons typically oxidise at 600 - 650°C (1100-1200°F). However, carbon monoxide (CO) production is relatively high at these temperatures. CO conversion to CO<sub>2</sub> requires temperatures of 760°C (1400°F) or higher. If the air stream does not contain sufficient VOC concentrations to sustain oxidation combustion, then additional fuel (natural gas or propane) must be burned to maintain the oxidation destruction temperature.
- **Turbulence:** Efficient mixing of the air stream avoids the unnecessarily high temperatures and/or longer dwell times that may be required to achieve complete oxidation. Turbulence is created using high velocity air streams and either changing their direction, or using turbulence-inducing obstructions in the air path. A drop in pressure normally occurs to achieve a good mix through baffles or a long chamber.
- **Time:** The amount of time that the entire air stream is maintained at the oxidation temperature affects thermal oxidation. Hydrocarbons generally oxidise in 0,1 to 0,3 seconds at 760 - 815°C (1400-1500°F), but CO conversion to CO<sub>2</sub> requires a minimum of 0,4 seconds. Oxidisers are usually designed with 0,5 seconds (or greater) total residence time.

1- USA principle for air pollution control is the % destruction of pollutants

2- EC principle for air pollution control is permitted residual quantity of pollutants

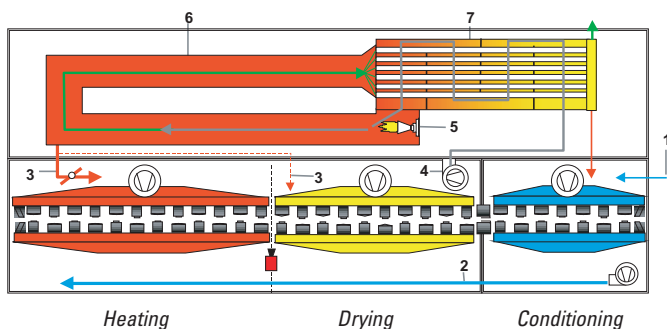

**Dryer integrated Recuperative Oxidiser:**

- 1 Make-up air,
- 2 Transfer,
- 3 Hot air supply,
- 4 Exhaust fan,
- 5 Burner,
- 6 Burning Chamber,
- 7 Heat Exchanger 65%.

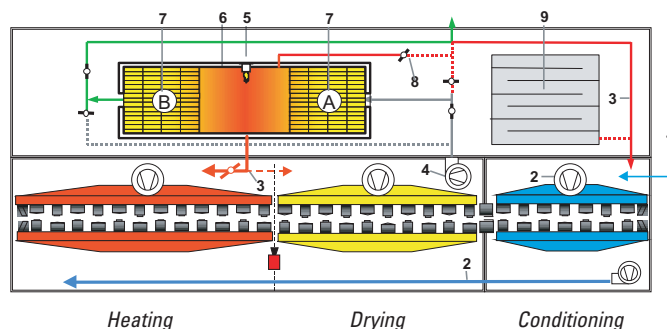

**Dryer integrated Regenerative Oxidiser:**

- 1 Make-up air,
- 2 Transfer,
- 3 Hot air supply,
- 4 Exhaust fan,
- 5 Burner,
- 6 Burning Chamber,
- 7 Ceramic Heat Exchanger 94%,
- 8 Hot side by-pass,
- 9 Residual air cleaner.

Source MEGTEC.

The time-temperature-turbulence relationship is critical to the oxidation system performance. Many designs fall short in the areas of residence time and mixing and, consequently, require higher temperatures to ensure high destruction efficiency. Nitrogen oxide (NO<sub>x</sub>) is a product of combustion and increases in volume as temperatures and fuel consumption increase. The regulation of NO<sub>x</sub> emissions is becoming increasingly stricter because it is a primary component in the production of ozone — these regulations may require the use of low NO<sub>x</sub> burners. Integral heat exchangers are frequently used to reduce the operating cost of maintaining oxidation temperatures. They pre-heat the process exhaust air before it enters the oxidiser combustion chamber. (See also Energy page 214).

### Recuperative Thermal Oxidiser

The term 'recuperative' describes a heat exchanger (metal shell and tube, or metal plate) that recovers 60-70% of energy from the oxidation process. The exhaust air from the dryer is pushed by a fan through the cold inlet side of the heat exchanger to pre-heat the air as it moves to the combustion chamber where the air is then heated to oxidation temperature. Most designs include static mixers or directional changes in the combustion chamber to ensure the air stream is thoroughly mixed. The residence time in the combustion chamber is normally 0.5 seconds to ensure complete VOC combustion.

### Regenerative Thermal Oxidiser

Regenerative heat recovery systems generally use multiple beds of ceramic media to collect and store energy between oxidation cycles. The ceramic media is contained in multiple towers that are interconnected by a combustion chamber at the top and a valve system at the base. The valve system directs the incoming exhaust stream between the towers. By switching from one tower to another, one ceramic bed will give up its energy while the other ceramic tower's energy is regenerated. The recovered energy is used to pre-heat the process exhaust air as it enters the oxidation system. Regenerative thermal oxidisers can recover up to 97% of the energy required for the oxidation process. RTO oxidisers operate at 815-980°C (1500-1800°F) and the ceramic heat recovery media and insulation used in these systems are normally capable of continuous operating temperatures of 980-1030°C (1800-1885°F). The high temperature capability and hot gas by-pass allow these systems to operate over a wide range of airflows with VOC concentrations of near 0% and up to 25% of the LFL (Lower Flammability Limit) for the VOC.

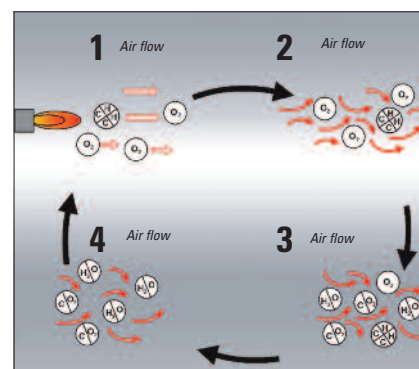

- 1 - Hydrocarbon molecules are heated to approx. 707° C /1400° F by oxidiser burner.
- 2 - Heated hydrocarbon molecules are mixed at high velocity with induced turbulence.
- 3 - Chemical reaction (oxidation) takes place between hydrocarbon and oxygen forming carbon dioxide and water.
- 4 - Carbon dioxide and water are exhausted into atmosphere or used as heat supply in a heat exchanger, then exhaust.

*The time-temperature-turbulence relationship is critical to the oxidation system performance.*

Source "Clean Air Compliance Handbook"  
MEGTEC Systems

# Postpress

Postpress operations can generate significant paper waste. Improved productivity begins at the folder exit.

**Product tracking and counting:** An important aspect of waste reduction is to print exactly the predetermined number of signatures. This requires an accurate product tracking solution in the press delivery system. Most conveyors have around 1 000 signatures in transit from the folder exit that if incorrectly counted are a repetitive source of avoidable waste. Copy count tracking systems should include the conveyor and use encoders to track the shingle stream with increased accuracy. This also allows waste from splice and blanket wash to be diverted more accurately to further reduce total waste. A back-up solution on the press delivery system can help reduce press down time. For example, if a rotary trimming line has a jam, the shingle stream is automatically diverted into a back-up system (second stacker or a print roll). These buffered signatures can be re-fed into the trimming line at the end of the print run.

**Quality of logs:** The quality of stacked logs has a significant impact on the productivity of postpress handling. Poor quality logs lead to reduced speed, frequent stops and higher waste.



A good log for the finishing department has all signatures aligned.



Protruding signatures at the beginning and end of a log (poor stacker separation) will be damaged by the strap leading to 6-10 waste signatures per log.



Poorly aligned logs leads to the overlaps being exposed to handling damage leading to frequent jams that stop the bindery line thereby increasing waste and reducing net output.

## Waste extraction of paper dust and trim

An efficient paper waste and dust exhaust system depends on its total design. This begins with specifications for the transfer points of the machine to the exhaust system and precise design data (machine type, assembly function, pipe diameters, minimum vacuum, flow velocity, volume flow). The exhaust capacity must be adequate to avoid heavy contamination that in extreme cases can cause blockages or even a fire. The measured values of an exhaust system can change during its service life if the system's flow resistance increases through blocked filters or deposits in the pipe system and suitable actions should be taken. Measurements should be made when machines are both in production and idle, and always on the same exhaust line based on highest load conditions (all machines producing, the exhaust system activated and all valves open). The two ways to check an exhaust system are to measure (1) the vacuum with a U-pipe; or (2) the air-flow speed. The first method is the most simple and practical. Large differences between the measured data and the specified values indicate defects in the exhaust system design.

**Dust-only exhaust systems:** Fans with cyclone separators or bag/container are used for a pure dust exhaust system for the splitting saw, binder milling, and spine preparation stations. A cyclone dust separator with filter should be connected if the dust is not blown into a separate dust bag/container or dust room. Two fans and two cyclone dust separators are ideal for the exhausting of milling and spine processing stations. High performance dust-only systems must have adequate capacity for the milling station and the various spine processing stations (levelling saw, sander, notcher, fibre rougher, brushes). A filter-cleaning device should be fitted to the exhaust to clean the separator. Note — a strip milling head cannot be used with these combinations because this type of exhaust system is not suitable for the extraction of shreds.

**Shred removal system:** The shred and dust removal fan for perfect binders and three-knife trimmers is a specific design. Normally there is one fan per machine. The piping should have as few bends as possible (with large radii > 500 mm) and a minimum 180 mm. The filter must have sufficient surface area to maintain the exhaust capacity.

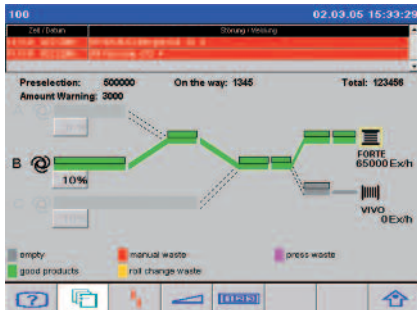

1

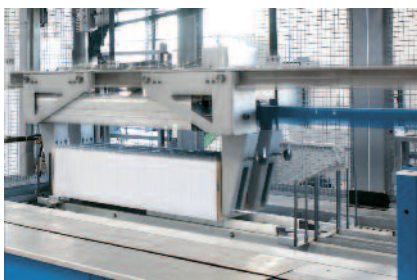

2

1- Newer control systems show the printer at the press control console the quantity of good signatures already processed in the log or compensating stacker, plus all signatures in transit on the conveyor. Photo Müller Martini.

2- Good quality of stacked logs improves productivity of postpress handling.

Photo Müller Martini.

## Best practice recommendations

- The separation of trim waste and dust is advantageous for disposal and recycling.
- The combination of different pipes should ideally be made horizontally — particularly for trim waste — to avoid any material falling back into a station. The connection of different pipes must be made in an apex angle and optimised for flow.
- The exhaust system design should have as little pipe curvature as possible — experience shows that up to three pipe curves are problem-free. The pipe curve radius (centre radius) should be at least three times as large as the pipe diameter. Pipes must be installed so that dust cannot accumulate anywhere inside — otherwise there is a danger of explosion. Pipe joints, forks and curves must be formed so that the transported material cannot get caught on protruding rivets, screws, etc.
- Plastic pipe connections are not recommended due to the static charge loading and fire hazards — they are illegal in many countries. (In Europe, conductive pipes must be used in the area of paper dust and comply with standard EN 1010.) The weight of vertical pipes longer than 2,5 m requires additional floor or ceiling supports.
- Flow velocities of over 35 m/sec should be avoided because they cause noise pollution and pressure loss.
- The vacuum given on layout drawings is based on the pressure loss of the assembly up to the connection flange. A piece of Plexiglas pipe can be installed directly above the valve for visual monitoring of the trim waste exhaust. The local standards and regulations for paper dust environments must be observed.

The same principles apply to inline press web edge trimmers and rotary trimmers.



Photo Müller Martini

Paper waste and dust needs to be efficiently removed from production areas, separated from transport air, compressed and prepared for transport. The type of system required is determined by production volumes and logistics. Systems can either be vacuum or pressure based (illustrated). Source Hunkeler

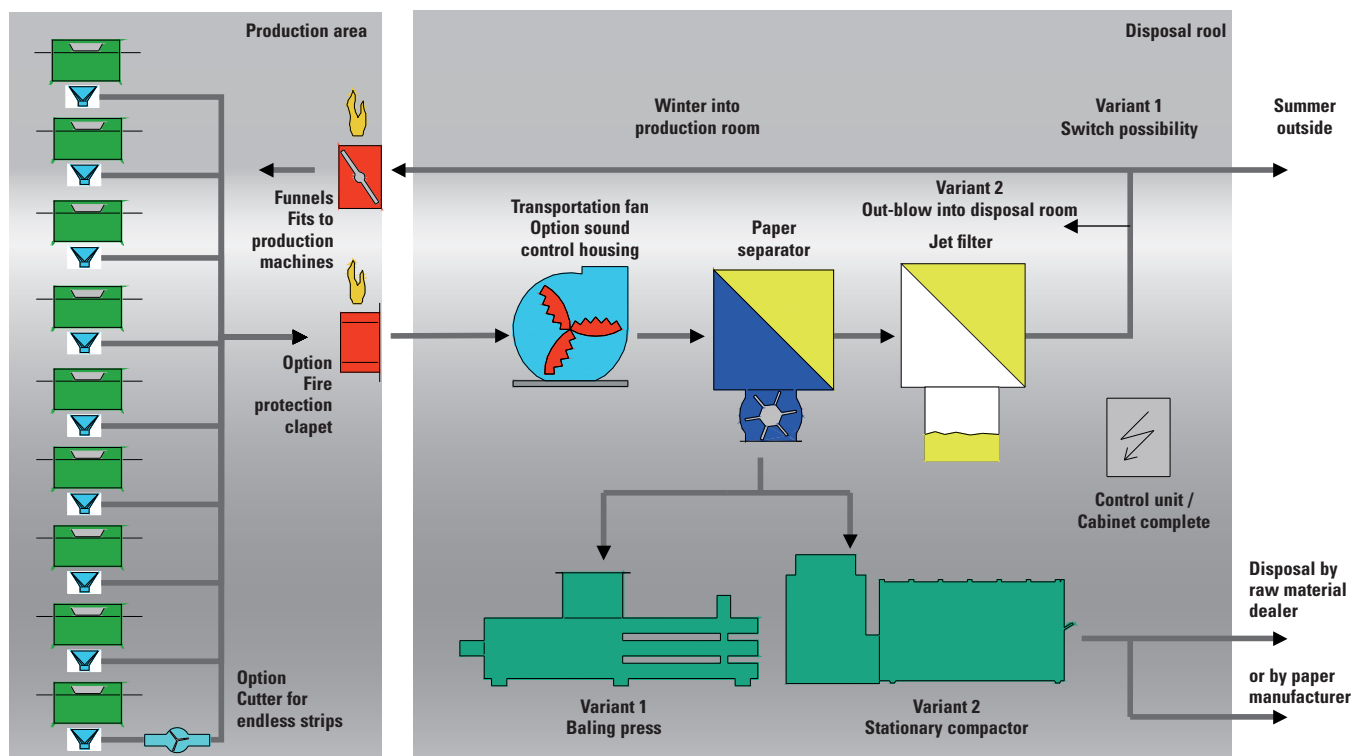

# Postpress

## Bindery adhesives



*Perfect binding is increasing using hot melt PUR adhesives because of their high page pull values, higher temperature and solvent resistance, and better aging characteristics.*

*Photo Müller Martini.*

Two main groups of adhesives are used in the printing industry, each having different characteristics and advantages. The criteria for adhesive selection are its suitability for the end product application, production method, total cost and environmental impact.

- **Cold melt aqueous (PVA, PVOH):** These glues have excellent aging, ink and temperature resistance, they lay flat and have stable rounding characteristics. However, their long setting time impacts on the total production cost.

- **Hot melt (PUR, EVA):** EVA-based adhesives are commonly used for book binding because of their economic and quality aspects. PUR (PolyURethane) is increasingly used in bookbinding because of its high page pull values, higher temperature and solvent resistance, and better aging characteristics. It allows binding paper with a lower amount of grain, or to bind-in laminated, UV coated or plastic signatures.

**Recycling:** Modern paper recycling plants use a flotation process that effectively treats glue contaminated paper (unlike older washing systems). Commonly used cold binding adhesives stay intact and can be screened out during recycling. Cold soluble adhesives dissolve into the pulp without problems providing their volume is not excessive. Hot melt adhesives should have a high melting point to allow better recycling by avoiding that they soften and squeeze through filters screens.

**Use:** Adhesive should be stored in sealed containers to prevent odours and dehydration of the product. Drip trays should also be placed under all dispensers to contain any spills. Hot melt emissions can be harmful to operators and systems should be installed to remove fumes.

**Disposal:** Non-soluble adhesive should be disposed of at a licensed disposal facility (not discharged to sewers). Water based glues can be discharged to the sewerage system depending on local authority requirements.

## Protective measures for PUR in perfect binding

PUR (PolyURethane) adhesives contain 0,5 to 8% free biisocyanatodiphenylmethane (isocyanates) that can be a health hazard by causing allergic reactions when in contact with the skin or if inhaled. Appropriate protective equipment and best practice procedures are required to avoid health risks. Clothes contaminated by adhesive must be changed immediately. Eating, drinking, chewing gum and smoking are prohibited in the immediate vicinity of PUR. Operations with risks are: heating the glue pot; cleaning the drum and pre-melter; changing the pre-melter can; rinsing and venting the pre-melter.

Isocyanates from the glue are only harmful to the operator when PUR is about 80°C. An exhaust system is recommended when heating and cooling the glue pot. There are no harmful emissions around the machine during production if the binder's extraction hood is closed. The ventilator of the fume exhaust system should not be installed directly on the binder, but about 1 to 2 m above it with an intermediate piece. This allows the fume particles to be deposited on the intermediate piece and not on the ventilator. Alternatively, a solid particle filter can be installed before the ventilator. The exhaust fumes must be led into the outside air in compliance with local regulations.



**Pre-melters:** There are three types of pre-melters: tank, drum or bag. Defined protective equipment should always be used and operating guidelines followed when refilling each system.

- No fumes should escape during operation and the cover seals must be in good condition. The fume exhaust system must run at all times and the ventilator never by-passed or disabled; regularly replace filters. Whenever possible, gluing station malfunctions should be fixed with the exhaust running.
- An efficient exhaust system must be used when refilling a pre-melting device with adhesive hot plugs — if this is not possible, then a respirator mask should be worn.
- Avoid direct skin contact with the adhesive and wear protective gloves.
- Hot adhesive must be prevented from splashing and may only be refilled after the corresponding message is displayed on the pre-melter.
- The adhesive must be prevented from overheating and temperature monitoring elements never by-passed.



**Cleaning PUR glue systems:** Always follow the manufacturer's instructions. Cold cleaning is preferred because no free isocyanates can escape into the ambient air (PUR adhesive that has already reacted with the air's humidity is completely harmless); no detergents or solvents should be used if the pots and rollers have a non-stick coating.

### Cold cleaning general procedure:

- Drain remaining glue from the hot pot into a container filled with water, then place the pot under the fume exhaust hood to cool off and finish reacting (6 to 20 hours). The PUR skin is then stripped off the coating and the pot is ready for the next operation.
- Dismantle other parts to be cleaned (rollers and partition walls) and place them in a container filled with water.
- Place the gluing station under the exhaust hood during the cooling process to ensure that no isocyanates are released into the air.

### Hot cleaning: General procedure, using specified cleaning agents:

- Always wear safety glasses and gloves (nitrile rubber or butyl rubber with long cuffs).
- Drain remaining glue from the hot pot into a container filled with water.
- The hot pot is further heated in a cleaning station with exhaust system. The hot pot is then cleaned using specified cleaning agents (these can be reused after filtering out the cured PUR).



The German Berufsgenossenschaft requires manufacturers to supply protective equipment for staff operating PUR gluing units:

1. Eye protection;
2. Leather work gloves for hot parts;
3. Nitrile Rubber Safety Gloves with Long Cuffs for cleaning;
4. Breathing mask with filter;
5. Spare filter;
6. Instructions for use;
7. Skin protection and care lotion.

Photo Müller Martini.

# Energy efficiency



Source EcoConseil/FICG

Energy expenditure	Reduce	Reuse	Recycle	Economy
Housekeeping	✓			▽
Machine drives	✓	✓		▽
Maintenance and settings	✓			▽
Compressors	✓		✓	▽
Process cooling	✓		✓	▽
Process heating and oxidation	✓		✓	▽
Internal transport	✓			▽
Buildings	✓		✓	▽
Lighting	✓			▽

Effective management of all energy (electricity, gas, propane, diesel and petrol) will reduce operating costs, improve working conditions and help protect the environment. Energy expenditure is a controllable cost offering significant scope for reduction to improve profits. Experience shows (UK and French studies) that if energy use has not been recently assessed it can usually be reduced by 10-20% using simple common sense actions to reduce consumption.

The cleanest and cheapest kilowatt of electricity is the one not used. Increasing electrical generation output is increasingly difficult and the US Department of Energy targets 66% of all energy gains must be from reduced electricity consumption — they are encouraging energy efficiency from Demand Side Management that includes the Green Lights and Climate-Wise programmes). Greenhouse gases are a by-product of energy consumption and cause global warming. More efficient energy use helps reduce carbon dioxide emissions to reduce the rate of climate change.

Energy consumption is variable due to each company's operating conditions and on what is classed as energy (e.g. inclusion of on-site transportation systems). In heatset printing, energy represents about 1,5-2% of turnover (ADEME France) and energy by use is typically: building heating 5-10%, machine drive 30-40%, cooling and refrigeration 10-20 %, compressed air 5 % with dryers and oxidisers using 25-50% — this is highly variable due to different technologies and configurations. In newspapers, the maximum energy draw when all equipment is running is split approximately 70-80% for production equipment, 5-10% lighting, 15-20% building and all other sources.

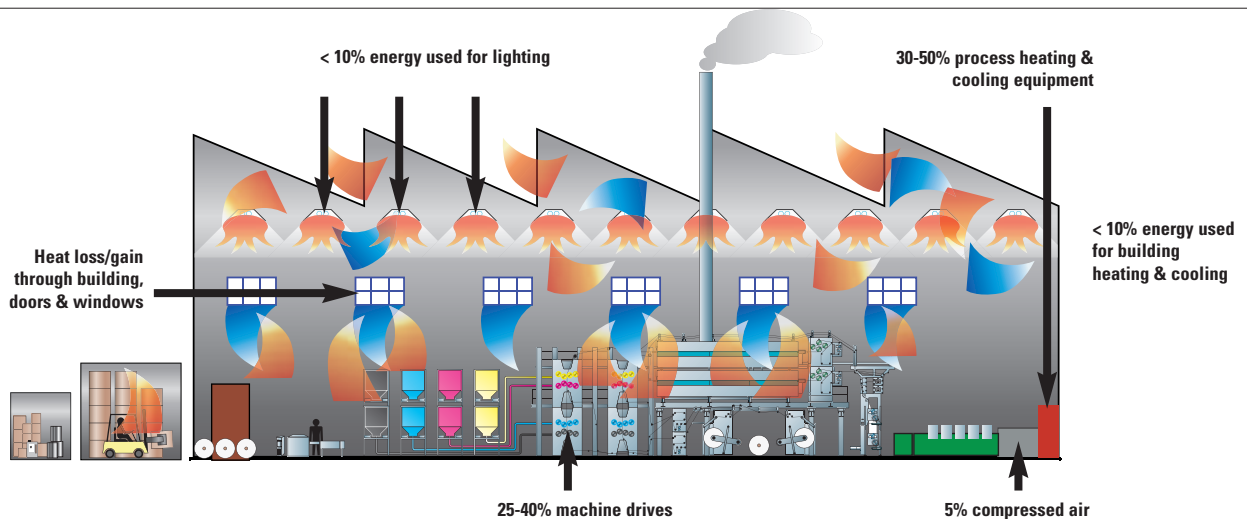

Source Mectec



## Develop an energy management strategy

- Does the site have an energy efficiency programme with a person responsible for it?
- Is the site's energy consumption known and regularly reviewed?
- Is the site as energy efficient as possible?

Create a team to implement energy management and use sources of expertise — government bodies, utilities and industry associations. Consultants may be useful to help make an initial energy audit and advise on a management programme.

### Best practice to manage energy

**1 Key Energy Performance Indicators (KEPIs):** How much energy is used, where and why? Analyse invoices for the last 12 months for each energy source and establish their total energy costs. Create a common energy measurement unit by converting each energy type into kilowatt hours (kWh). Compare monthly data and check tariffs. Avoid variations by reading meters yourself because they are rarely read on same day each month. Calculate the base energy load during months when there is no heating or air conditioning consumption. Lighting consumption can be estimated by multiplying installed kW load by the hours in use. Estimate the load by the number of fittings and their power rating (conventional fluorescent lighting is typically 10-20 W/m<sup>2</sup>). It may be useful to separate production and office areas if they use different types of lighting.

**2 Compare data:** Use graphics to present data in a format that allows analysis of energy per m<sup>2</sup>/ft<sup>2</sup>, energy per tonne of production, energy per tonne of raw materials (paper and ink), energy per unit of turnover, energy per employee.

**3 What are the potential savings?** Production-related, or buildings/general services, or lighting? Rank the most important potential savings area and concentrate on one to demonstrate success before moving to another.

**4 How to achieve savings?** Set targets, monitor results, give feedback, ask for ideas. Most people are willing to help if they understand the problem. Motivate staff to share ownership of tasks and solutions and recognise their success. Assess investments that provide good ROI from energy savings.

**5 Housekeeping:** The cumulative cost of small incidences of wasted energy are significant. Train and motivate staff to use better working practices: switch off computers, printers, copiers and lights when not in use; close doors; consider installing occupancy sensors to automatically control lighting and equipment.

**6 Energy purchase costs:** Are you paying the best rate for energy? Verify with your supplier(s).



Source EcoConseil/FICG

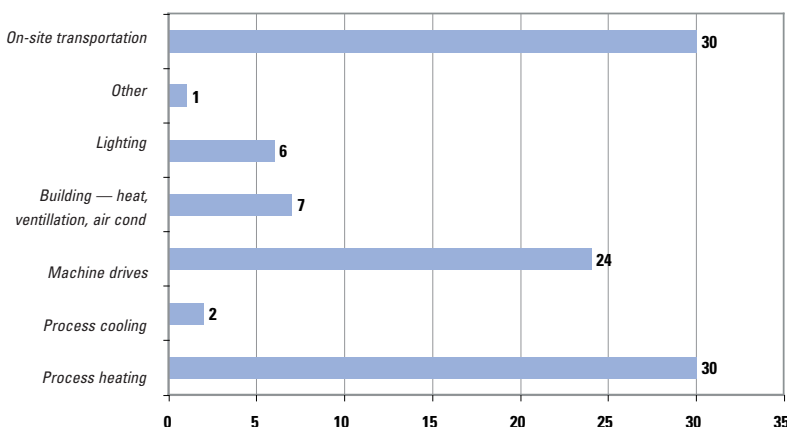

*Manufacturing energy consumption survey of all energy sources (natural gas, electricity and propane) in 2002 at 24 printing plants of Quad/Graphics (predominantly heatset with some gravure). Transportation is mostly fork-lift trucks. The lighting proportion was previously 8,5% but reduced to 5,50% by fitting new technology system (see page 223).*

Source Quad/Graphics.

# Where are the wasted kWh's ?



Stop expensive compressed air leaks from pipes, joints, hoses, couplings, regulators.

Source EcoConseil/FICG.

## Energy recovery

Heat recovery can be used for space or water heating to reduce energy consumption. Assess if excess heat from presses, compressors and cooling systems can be used to heat other areas of the factory such as the paper store or loading bay air curtains. About 70% of electricity used by compressors and suction pumps is rejected as heat. Consider situating compressors near points of large air demands to minimise pipe runs and operating costs (in the summer months this heat needs to be ducted to the atmosphere to avoid overheating the building).

## Machines

The energy efficiency of a machine is determined by its manufacturer and should not normally be interfered with.

- Some governments provide tax or other incentives to install 'approved' frequency drives that reduce energy draw — this should preferably be done in collaboration with the original machine manufacturer.
- Request your suppliers to identify operating procedures that minimise energy consumption.
- Minimise energy consumption by optimising machine utilisation, reducing stand-by time, using correct operating procedures and reducing makeready time.
- Regular preventive maintenance is important to ensure that air filters are not blocked; correct lubrication is made and settings are correct — the higher the mechanical resistance the more power is required.
- Ancillary equipment (compressors, cooling and drying) can be sources of significant energy savings.
- Compare energy consumption of new equipment to ensure lowest lifetime energy costs.

**Electric motors:** AC motors are now preferred to DC because they are largely maintenance-free, easy to start and provide maximum torque at low speeds. In addition, when AC motors are used for breaking they generate electrical current that can be used by other frequency controlled drives. Most new machines are equipped with more electrical drives to replace functions that were either mechanical or pneumatic (high cost of compressed air).

**Air compressors:** Significant energy savings are available. Typically 30% of energy is lost from air leaks that are frequent and cumulatively expensive (1 mm<sup>2</sup> = € 1 per day). Air leaks lead to pressure drops that are compensated by increasing the pressure to maintain operating functionality — an additional 10 psi increases power demand by 5-7%.

- Have you got a 'whistling factory'? Turn off all the machines and listen for the background hiss of compressed air leaks.
- Stop leaks from pipes, joints, hoses, couplings, regulators. Use an ultrasound device to identify leaks.
- Turn-off compressors when not in use.
- Compressors should be sized as closely as possible for the required load; it is uneconomic to run them for long periods at low loads due to electric motor inefficiencies.
- Use external air intakes that generally have a lower temperature than internal air (protect inlets from wind and rain).
- Ensure that pressure is adapted to requirements of different equipment. Ideally compressors should be fitted with automatic shut-off valves and an additional shut-off valve should be added for units using very high pressures.

Energy consumption can be reduced by about 33% by centralising compressed air generation and on-demand sequence control saves 5-20%. Centralisation makes maintenance, noise insulation and heat recovery easier — about 70% of electricity consumed is turned into heat. If plant-wide centralisation is not possible, then install a single system in each department with automatic closure of the air system when switched off.

**Prepress:** CTP plate systems eliminate the film process step and the energy used.

**Presses:** Presses are generally the largest energy consumers. However, the replacement of mechanical shaft drives by AC frequency controlled drives has reduced their energy draw by about 50%. More automation significantly reduces total production energy consumption and materials waste by allowing faster start-ups with fewer press stops.

**Blankets:** Presses have a high number of rollers and contact zones with complex rolling behaviour including the viscoelastic behaviour of elastomers and the composite structure of blankets. Direct drive systems now allow individual unit power consumption analysis.

Three blanket parameters have a measurable impact on press power consumption:

- Higher packing increases the mechanical load in the contact zones and increases the energy converted into heat that can also disturb process stability.

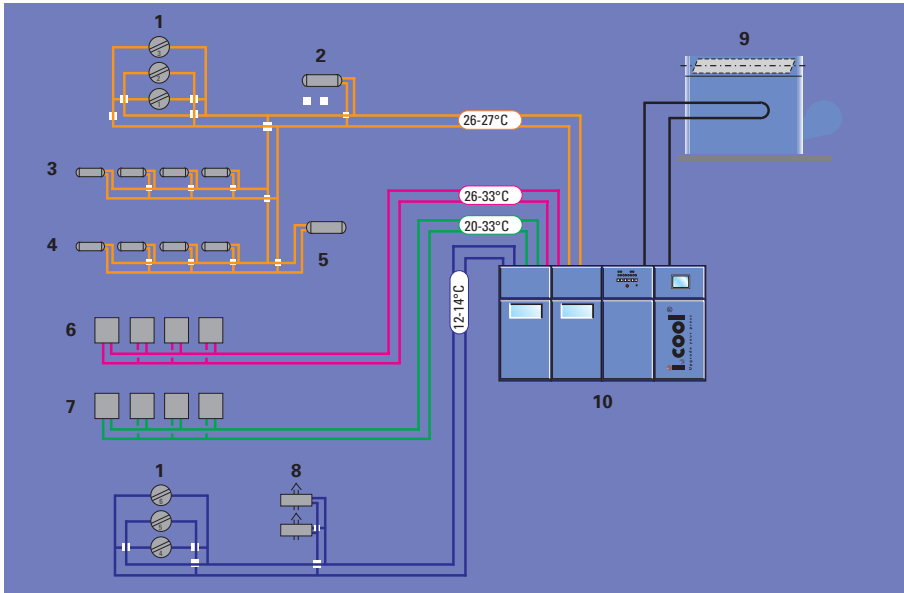

A fully integrated press cooling system with a closed cooling tower offers very high energy efficiency. Source Axima.

- 1 Chill rolls
- 2 Gear-oil cooler folder
- 3 Gear-oil coolers printing units
- 4 Coolers electronics AC-drives
- 5 Condenser of dampening water device
- 6 Ductor rollers
- 7 Oscillating drums
- 8 Air blowing coolers
- 9 Closed cooling tower
- 10 Central Unit

- Blankets have to be designed and selected for press speed and energy efficiency (like car tyres).
- Speed mismatch between blanket-plate cylinders, or blanket-impression cylinders, creates poor rolling with an imbalance in drive power consumption and indirect wasted energy.

### Press cooling system



#### Poor practice

- Cold water production by cost intensive air cooled compressor chillers — these draw more primary energy than water-cooled types because of the changing temperatures in the condenser.
- Using split systems (separate condenser of refrigeration machine) risks losses from the high volume of refrigerant liquid.
- Very large chill plants for multiple presses do not work efficiently under partial load.
- Frequent switching of refrigeration machine shortens lifetime of their components.
- Imprecise control of water circuit temperatures.
- No redundancy back-up because of a single chill water generator.



#### Best practice

Evaporative cooling (closed cooling tower) combined with a water cooled refrigeration unit can provide energy savings of up to 70% because:

- PLC control maintains precise temperatures in all circuits with automatic monitoring of functions.
- Cold water storage tank allows constant and optimal efficiency.
- Oscillators and doctor rollers are at preset temperatures before the press starts and the temperature is adjusted to web speed.
- Reliable operating conditions with longer component life from reduced switching; independent refrigerating circuits; reduced wear on moving parts (constant temperature conditions in a closed, dirt-free refrigeration circuit); back-up from independent chill water generators. Compact dimensions.

Some printers automatically route cold water for the chill rolls through an outdoor chilling unit when the external temperature drops below 18°C/65°F. This considerably reduces energy with an ROI of around 2 years.



Photo Axima

# Where are the wasted kWh's ?

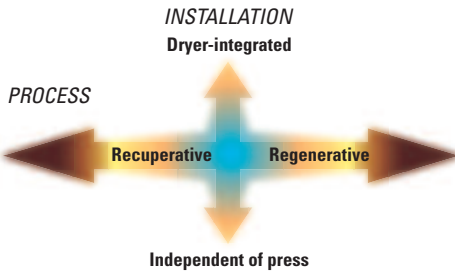

There are two installation choices for heatset oxidisers. Either an independent unit or as an integrated dryer-oxidiser mounted on the press. There are two process choices each with different energy efficiency.

## Energy efficiency of heatset systems

Energy efficiency is determined by the choice of installation (on or off press) and the type of oxidation process choice. (See page 208 for oxidiser emission control selection criteria.)

There are two installation choices for heatset oxidisers: centralised independent oxidisers that usually serve several presses; or an integrated dryer-oxidiser mounted on the press. The majority of installations are now dryer-integrated (except in the US) because they have a higher energy efficiency that is directly related to the job being printed and allow complete production flexibility. Independent plant-wide multiple dryer systems usually require long duct runs from the dryer to the oxidiser unit and typical installation costs can be 50-70% of the capital equipment cost. The integrated dryer-oxidiser is a fully closed-loop operation that recycles the energy contained in ink solvents during the drying process and transfers it to the oxidiser as energy for oxidation. The heat generated from oxidation is then transferred back to the dryer to reduce its gas consumption.

**Oxidation energy efficiency** The two principal web offset processes are the traditional Recuperative system and the more recent Regenerative Thermal Oxidation (RTO). Both use integral heat exchangers to reduce the energy cost of maintaining oxidation temperatures. They pre-heat the process exhaust air before it enters the oxidiser combustion chamber. For processes with large variations in solvent load, it is necessary to vary the efficiency of the heat exchanger using cold or hot side by-pass dampers.

An energy assessment (ADEME, France 2000) identified that heatset energy consumption can be reduced by:

- 50% energy saving by replacing non integrated recuperative oxidisers with integrated recuperative dryer-oxidisers.
- 50-70% energy saving by replacing offline recuperative oxidisers with off-line Regenerative Thermal Oxidation (RTO).
- Replacing integrated recuperative oxidisers with integrated RTO dryer oxidisers give the highest energy savings possible (system only a prototype at time of evaluation).

**Recuperative Thermal Oxidisers:** 'Recuperative' describes the heat-exchanger that in production can recover between 60% to 70% of energy. Heat exchangers are either a metal shell-and-tube, or a metal plate. Their efficiency is affected by the temperature of the process exhaust; operating temperature requirements; temperature stratification within the unit (relating to flow turndown, type and concentration of the VOC treated); and the process operating cycle. These combined factors determine efficiency and operating life. Temperature limits of the metals used in the heat exchangers and stresses from changing process conditions can severely reduce operating life. For this reason, high quality systems use high-grade metallurgy that increases their acquisition cost.

**Regenerative Thermal Oxidation (RTO):** Regenerative heat recovery uses beds of ceramic media to collect and store energy between oxidation cycles. Systems are available with 1, 2 or 3 beds of ceramic heat exchanger media that has a long lifetime. The regular reversing of flow direction efficiently transfers heat between ceramic bed media and the process air passing through the system. RTO is the most energy efficient oxidiser available with an ultra-high efficiency (95%) heat exchanger. The higher the energy released from the oxidation of processed solvents, the less auxiliary fuel is required. In many production conditions the unit requires no additional energy because it is self-sustaining using only the energy from the process solvents.



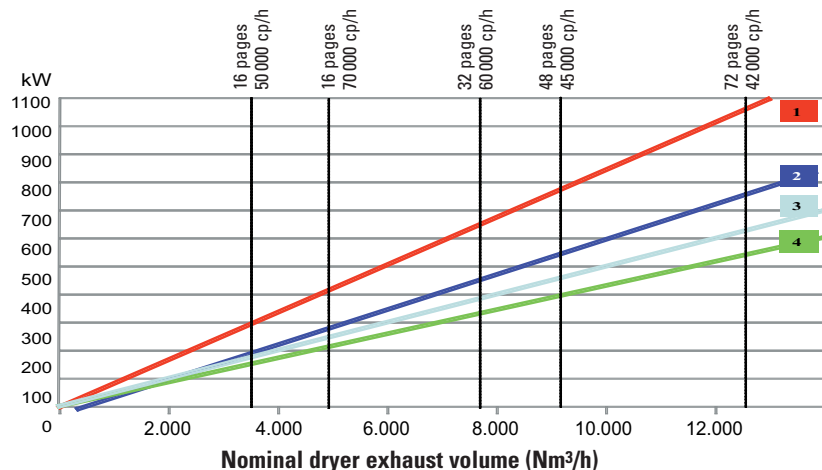

Comparative kW energy recovery potential from different types of oxidisers when printing 1,5 gsm of ink on 60 gsm paper.

1. Independent Recuperative,
  2. Integrated Recuperative,
  3. Independent RTO,
  4. Integrated recuperative + LEL control.
- Source MEGTEC.



Other energy considerations when selecting dryer-oxidisers includes the thermal efficiency and electrical consumption of the air bar system, use of frequency controlled process fans, exhaust reduction system, and low exhaust flow rate in stand-by. Most dryers-oxidisers can be fitted with secondary heat exchangers for energy recovery to produce warm or hot water.

**For optimum production speed and energy consumption:**

-  Regular preventive maintenance (see Guide N° 4 “Productivity Maintenance” pages 26-27) and cleaning of all filter screens and internal pyrometer.
-  Adjust each dryer zone to suit each paper grade (not just web temperature set point alone) and adjust chill rolls. Set temperature to the minimum necessary to evaporate the solvents.
-  Too high temperatures wastes energy, it also encourages ink deposits and solvent condensation on the first chill roll lowering its heat transfer efficiency and causing marking.
-  The chill rolls must always be regulated with the dryer as part of an integrated heatset system. Their thermal efficiency can decline if there is surface build-up linked to paper grade and web flotation over the chill roll (see Guide N° 2 “Web breaks” page 24). Internal scaling of cylinders by water contaminants builds up scale that progressively reduces energy transfer leading to marking and speed limitation.

**Transport**

**Fork-lifts**

-  Review physical workflows to minimise distances travelled and introduce best practice procedures:
    - Shut down the unit if it is not used for more than 3 minutes or if the operator is more than 6 m (25 ft) from it.
    - Effective maintenance programmes for LPG units will significantly improve their overall performance: lower running costs, doubling of average service life (from 10-15000 to 20-30000 hours); lower fuel consumption; and less air pollution. Service intervals can be almost doubled by using high quality consumable products (oils, lubrication, filters, etc.). This also means less waste to dispose of. Regular adjustment of valves and timing helps reduce fuel consumption and air pollution. Use infrared monitoring to check LPG exhaust emissions at every service.
    - Record preventive maintenance, damage and repairs to ascertain when equipment should be re-allocated to a lower use application to fully depreciate the unit. Allocate new units to the most severe applications to fully utilise the warranty.
- Many of these best practices also apply to diesel powered units. Maintaining exhaust filtration in an optimal state is particularly important if they are used inside buildings.

**Company vehicles**

- Service them regularly to increase fuel efficiency and reduce emissions.
- Minimise distances travelled by co-ordinating deliveries and collections.
- Train drivers in fuel conservation driving techniques.

**Geodata Information Systems (GIS)**

GIS-supported route planning can reduce transport costs by up to 20% compared with manual planning. GIS is a tool to improve transport logistics by analysing all transport routes as a digital network between production sites, depots, discharge points and individual subscribers. It can consider access and time restrictions, vehicle load capacities and to optimise transport routes by cost or time. GIS can also improve delivery routing, micro zoning and site location for production operations and is becoming an important competitive factor as mass markets progressively disintegrate into smaller and more specific segments. GIS correlates individual reader profiles with the publisher’s distribution areas to optimise insert delivery only to the defined micro target groups.

 To determine which system provides the best value all costs should be considered. A higher capital equipment investment usually means higher heat exchanger effectiveness, lower energy consumption and longer life. Total life cycle cost is the common denominator to compare different systems with different lifetimes. The essential factors to be considered are:

1. Energy consumption in operation (gas and electricity)
2. Life expectancy and maintenance
3. Capital equipment and installation costs
4. Reliability/availability
5. Ability to reclaim and use oxidiser waste heat

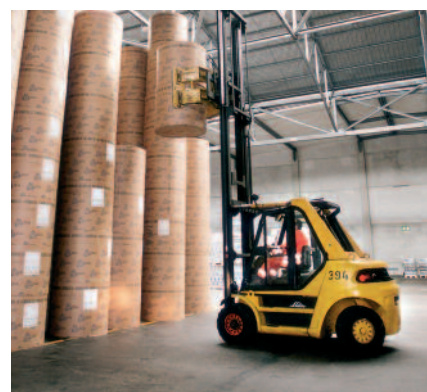

1



2

1- Effective maintenance programmes for LPG and diesel fork-lift trucks will significantly improve their overall cost performance. Photo SCA.

2- The environmental and economic performance of road transport can be improved. Using an auxiliary diesel power unit to heat and cool the truck’s cab avoids idling the engine when parked to reduce fuel consumption by around 80%, carbon emissions and noise levels. Photo Quad/Graphics.

# Where are the wasted kWh's ?

## Buildings & Services



Source EcoConseil/FICG.

Industrial buildings account for about 50% of greenhouse emissions, and their services about 20% of primary energy consumption (UK survey). Typically, building energy consumption is around half of what is used for production. However, potential savings are more readily available in this area from:

- 1 Eliminating excessive consumption from over-heating, lighting areas not in use, air leaks and draughts.
- 2 Maintaining desired conditions (temperature, humidity, light) by monitoring or control. Assess the benefits of computerised control of heating, ventilation, air conditioning and other support systems.
- 3 Improving energy efficiency of buildings. For new buildings, include solar and natural efficiencies, correct orientation to sun and prevailing winds, and use of energy efficient materials. Existing building efficiency can be improved to generate good return on investment. Key elements that effect building energy efficiency:
  - Construction materials and their insulation properties; position of doors, windows and ventilation; external window shading; space heating/cooling; hot water supply; lighting.
  - Efficient summer ventilation — even in temperate countries — can be more important than space heating due to excessive heat build-up from the equipment used.
  - Design and layout can have a major impact on energy use, materials transport and physical workflow.
  - Unloading doors are a large source of air leaks and draughts, particularly if there are doors at opposite ends of the building. This can be reduced by: partitioning the loading bay; using plastic strip curtains; heated air curtains and seals in the loading bay. Push-button door operation encourages employees to close doors. Fit self-closing doors at external exits and between departments. In some cases install windbreaks around external doors.

### Solar solutions save money

- Production sites that experience high summer temperatures can reduce internal temperatures of walls exposed to direct sunlight by 6-8°C by covering them with green creepers. A deciduous creeper over windows is very effective to reduce internal temperatures and far more efficient than internal blinds. For companies with air conditioning this will reduce energy demand, and for those companies without, a low cost method to lower factory temperature.
- Many industrial buildings have flat roofs that are often covered with a heat-absorbing material (like tarmac) that reaches excessively high temperatures in summer. Covering the roof with vegetation provides good insulation against summer heat penetration and winter heat loss. This approach reduces energy consumption, cleans the air, reduces water run-off and extends the life of the tarmac covering by about 300%. Green building solutions also have a high aesthetic impact on customers, neighbours and staff.
- In regions with extremely hot summers and/or cold winters it is possible to pre-condition air by running it through ducting buried about 2 m underground to significantly reduce cooling/heating energy required. Ground water stored in the soil can also be used for cooling purposes and solar collectors to generate hot water.

### Sources of heat build-up

When a press starts up, the web's motion creates large and rapid air movement which quickly changes humidity and temperature. If the replacement air is too cool it can create local cold spots and operating problems. Heat is generated by the press, its electronic equipment (and dryer if fitted), through windows and the roof and walls of the building. The difference between summer and winter internal temperatures can be up to 20°C/68°F and poor ventilation can add another 20°C/68°F. Optimum printing conditions may only be obtained in some locations by factory-wide climate control.

On a heatset press, the temperature around the yellow unit next to the dryer is up to 15°C/59°F higher than the comparatively open first unit. The unit temperature of an enclosed press can be 10-20°C/50-68°F higher than an open line. Soundproof booths should be equipped with a balanced air control system.

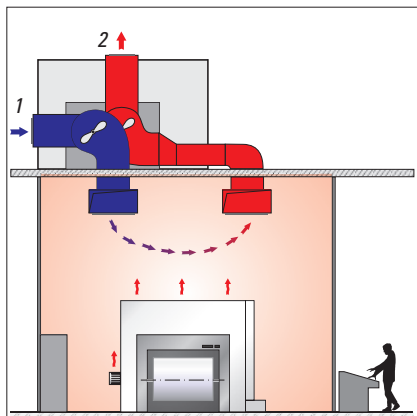

The supply air (1) entering the press enclosure takes a short and ineffective route to the exhaust (2).

Source Axima.

The supply air (1) enters the press enclosure at ground level and is the natural thermal air flow travels upwards to the exhaust point (2).

Source Axima.

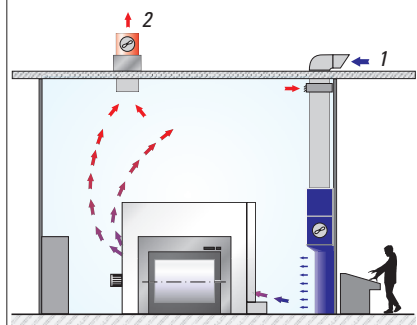



### Poor practice:

- Flow rate of supply air not adapted to requirement of printing press; poorly positioned supply air outlets and exhaust air ducts; poor building insulation.
- Use of primary energy to heat up the cold outside air.
- Draughts at the printing units. Temperature too high around the yellow unit
- Not using the natural thermal current of the printing press
- No air pressure balance inside the sound enclosure negatively effecting the rest of the building.
- Use of energy-intensive air conditioning systems.
- Ventilation equipment installed in a separate room with long ductwork.
- Moistening systems that are cost-intensive to run and difficult to maintain for hygienic requirements.
- Insufficient filter capacity with very short maintenance intervals.



### Best practice:

- Optimum adjustment of supply air flow rate to the requirement of the press with multiple measurements on the installation.
- Micro-processor controlled pressure compensation inside the sound enclosure eliminates thermal influence on the area outside.
- Position of supply air outlets and exhaust that follow the natural thermal current of the printing press.
- Short air-ducts to reduce ventilator power consumption (< 50% less energy than conventional systems).
- Using displacement air diffusers for draught-free air introduction.
- Compact supply air units with large filter elements.
- Energy recuperation of waste heat from equipment.

## Heating & Cooling

Workplace heating is a high cost that can be optimised. Efficiency is related to the type of heating system, its setting and maintenance; insulation; heat recuperation from production machines; and behaviour such as air leaks from open doors. Potential savings from heating systems include lagging pipes, installing fan motor or oxygen trim control. Better control systems to eliminate dry cycling that can save 8-10% of energy. Each 1% of surplus air in the system increases fuel consumption by around 3%. Condensing boilers for hot water generation have the highest efficiency.

**Too hot?** Set the thermostat at 19°C/66°F - costs rise by 8% for every 5% increase in temperature.

**Don't heat unused space:** Storerooms, corridors and areas where there's heavy physical work can be set to lower temperatures. Reduce heating during holidays and weekends.

**Keep radiators clear:** Don't block radiators with furniture — it reduces efficiency and output.

**Thermostats:** Check that thermostats are sited out of draughts and away from either cold or hot spots.

**Keep windows closed in cold weather:** If staff are too warm, turn the heating down instead.

Heating system setting and control is a high priority to maintain target temperature — 1°C more can add 10% to the heating bill. Digital thermostats are accurate to 0,5°C and can save 10-15% of heating costs compared to older thermostats that are generally only accurate to 2°C. Correctly position thermostats so that they are responsive to control the relevant area to avoid over-heating. Thermostats should be checked at the end of summer to make sure they are working correctly. Optimised heating system cold-start control should account for changes in external temperature and building heat-up rate to optimise pre-heating.

Good insulation and passive thermal efficiency significantly impact the amount of heating/cooling required. The space underneath the roof is often overheated (stratification) in factories with ceilings over 6 m. Thermostat-controlled fans can be cost-efficient to blow down this heated air to lower level.

Direct heating such as infra red may be suitable for some areas such as large spaces where work is concentrated in specific areas, or subject to frequent change like loading bays. They have the advantage of almost instant heat delivery and in these areas are more efficient than radiators.

## Air conditioning

It is quite common for air conditioning to use up to 30% more energy than it should. Ensure the unit is clean, the heat exchanger surfaces are free of dust, and that air flow through grills and ducts is unobstructed. Temperature and time setting need to be correctly set and regularly monitored.

Generate chilled water with absorption chillers where heat recovery from other processes is possible.

Cool supply air using cooling where surplus heating energy is available (e.g. from co-generation systems) to reduce mechanical cooling.

Air distribution by means of displacement air systems — higher supply air temperature, reducing mechanical cooling due to longer periods of outside air temperature below supply air temperature and lower fan power due to reduced air flow rates (larger temperature differences between supply and return air are possible).



1

*1- An alternative to plant-wide air conditioning in the US is "spot cooling" in the pressroom. Conditioned air is brought only to vents at the press consoles to give better temperature control where the pressmen spend most of their time. Photo Quad/Graphics.*

# Where are the wasted kWh's ?



1



2

1- Accurate measurement allows companies to assess potential savings and verify them. The best way to choose an industrial lighting fixture is to determine its electrical throughput — measure the electrical wattage of the fixture multiplied by the diffused lumens/foot-candles in the workspace.

Photo Orion Energy Systems, WI, USA.

2- Quad/Graphics saved 3.5 megawatts of electricity by replacing 14 000 industrial light fixtures in its 24 plants with T-8 fluorescent systems fitted with electronic ballast and optimum reflector design to produces 50 % more light and reduce power consumption by 52% to give an ROI of less than two years.

Photo Orion Energy Systems, WI, USA.

## Comparative lighting technologies

	HID	T5	T8
Cost of lamp and ballast	●●●	●●	●●●●
Energy consumption per lumen	●	●●●	●●●●
Efficiency loss in operation	●	●●●	●●●●
Colour rendering	●	●●●●	●●●●
Running temperature	●	●●●	●●●●
Level of glare	●	●	●●●●
Stability	●●	●●	●●●●
Flickering	●	●●●	●●●●
Proven technology	●●●●	●	●●●●
Available in standard lengths	●●●●	●	●●●●

Comparative assessment from a year-long test of T5 and T8 technology in comparison with HID.

Source Orion Energy Systems, WI, USA.

## Lighting

Lighting on average consumes 35% of all electricity used by businesses and it is significantly higher for warehouses and distribution centres (U.S. Department of Energy). Around 15% of the UK's total electrical consumption is used for lighting. Annual costs are very high for printing plants operating 24 hours/day and this is often the best place to start an energy management programme because energy efficient lighting technology offers a large source of sustainable cost reduction, improvement to the workplace and helps protect the environment by replacing out-dated high-bay fixtures. The choice of lamp system is a key factor in energy efficiency as new lighting technologies can save up to 50% of energy, provide 50% more light, and give an ROI in around 2 years.

**High Intensity Discharge (HID):** Traditional HID lighting fixtures have been the primary lighting choice for industrial purposes for over two decades. HID fixtures can be described as being better sources of heat than light as most burn at over 510°C/1000°F, generating 4°C/40°F of heat in an average factory. In addition, they lose 30-40% of their efficiency within the first year of use because of their excessive heat and ballast vibration (a ballast device provides the start-up voltage and stabilises current for fluorescent tubes). There are now a new class of more efficient ceramic metal halides (MH) with higher lumen maintenance, better colour rendering and longer life. However, they are not yet competitively priced.

**New lighting technologies (T5 and T8):** These are more efficient than HID. The T5 is suited to architectural lighting and where there are multiple on/off cycles. However, they are a point source light with high glare, run hotter, use more watts, produce less lumens and are relatively expensive.

The T8 has none of these problems and is ideal for industrial lighting applications and particularly suited to work when enclosed because of its low heat generation. New generation T8 fluorescent lamps with electronic ballast and optimum reflector design deliver 50% energy savings with 50-100% more light than traditional lighting. They also keep 93% of their efficiency over a five-year life and produce "full spectrum light" — equivalent to sunlight at noon. Instant on-off switching allows motion and ambient light sensors to be used to further reduce electricity consumption in spaces not being used, or when there is adequate natural daylight. Controls can be set for time, daylight or occupancy with localised switching. Unless switching arrangements are convenient lights tend to get left on. Light fixtures should be regularly cleaned otherwise their efficiency declines. The T5 and T8 are international products. The T5 (5/8" ) is a European product with its length in metres and is therefore non-standard in the US; T8 (8/8" ) is a US product in standard 4 feet lengths, non-metric standard.)



# Noise and the environment

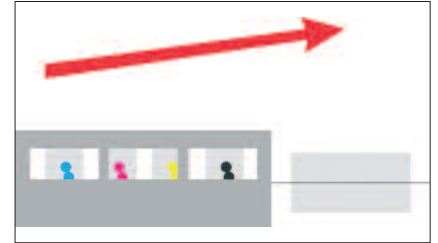

2

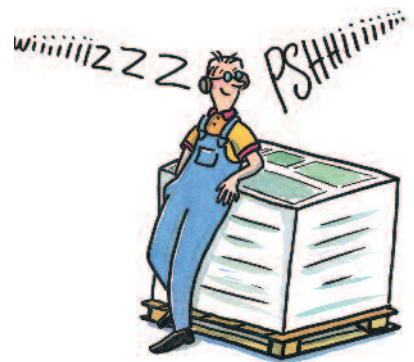

1

Noise can negatively impact on employees and the surrounding community and can be particularly annoying if it is either impulsive (distinctive and highly intrusive in nature) or tonal (cyclones, extraction units etc.). Noise levels and exposure time determine noise dosage and long exposure to high noise levels will result in hearing damage. There is a correlation between high noise levels and worker productivity, stress and absenteeism. Noise travels directly or by reflection (reverberation) and is generally the result of multiple sources of sound from machinery, delivery trucks, compressors, generators and extraction fans.

Noise levels are subject to European Community directives for employee working conditions, and a maximum sound pressure level of 83 dB(A)-weighted decibels is allowed in the printing industry (A-weighted means the decibel value in relation to the sensitivity of human hearing). As a rough guide, two people have to shout to be heard if they are 1 m apart at 90 dB or at 2 m at 85 dB. Financial penalties for non-compliance can be high. If it is suspected that noise generated at the site is excessive beyond its boundary a noise survey can be made to determine the actual noise levels against permitted noise levels.



## Actions to manage noise include:

- Measure noise in the workplace to identify critical areas.
- Inform employees about noise and protection.
- Limit number of people exposed to high noise levels and generalise the use of ear protection — obligatory above 85 decibels.
- Zones above 90 dBA should be marked 'dangerous' and ear protection is mandatory.
- Particularly noisy areas should be isolated from other areas.
- Where possible noise should be limited at its source by sound enclosures (particularly air compressors and press folders) or sound-suppressing machine covers. When choosing new machines request noise level specifications and measure after installation to make sure they are met.
- A sound proof operating cabin can be a good solution for web presses with a high level of remote control and automation.
- Anti-vibration supports prevent vibrations transferring through the floor. Sound-absorbent wall and ceiling coverings may be useful (a good absorbing material admits sound and then dissipates it by changing the acoustic energy to heat).
- Prevent noise being transmitted to the exterior through doors and windows.
- A reduction of around 10 db can be achieved by using insulation to reduce the noise bouncing off concrete walls.
- Equipment should be regularly maintained to run without rattles or vibrations; The potential for noise complaint is increased when plants are close to residential areas and work 24 hours a day. The perceived level of noise increases at night and weekends because of the absence of general daytime background noise. Some extra precautions include:
- Limit most vehicle movements to day-time working hours;
- Limit the use of bells and public address systems to standard day-time working hours; and ensure external facing windows and doors are closed when working outside standard hours. There is a risk that enclosure of the press units, or complete press line, may negatively impact operating temperatures — this needs to be assessed and addressed with ventilation and humidifying systems. See also pages 36-37.

1- Sound proofing is an extremely effective method to reduce high and consistent noise levels. Photo Faist.

2- Press sound enclosures can significantly affect the temperature profiles of the print units and require effective ventilation. Source WOCG.

3- The use of ear protection is obligatory above 85 decibels. Source EcoConseil/FICG.



## BEST PRACTICE

### Aylesford Newsprint

**Aylesford Newsprint** is a dedicated manufacturer of premium quality newsprint. Its "Renaissance" brand is widely used by many major European newspaper publishers. The mill specialises in 100% recycled newsprint of exceptional runability and superior printability — brighter, cleaner and with high opacity. All products are made exclusively by recycled paper using highly skilled staff operating the most advanced technology available. The company's continuous improvement programme helps ensure the attainment of the highest operational and environmental standards. Aylesford Newsprint is jointly owned by SCA Forest Products and Mondi Europe who bring a wealth of experience in quality paper manufacture.

[www.aylesford-newsprint.co.uk](http://www.aylesford-newsprint.co.uk)

### Kodak

**Kodak GCG** (Graphics Communications Group) provides one of the broadest product and solutions portfolios available in the graphic arts industry today, including a wide range of conventional lithographic plates and Computer to Plate solutions; Kodak GCG branded graphic arts films, digital, inkjet, analogue and virtual proofing products, as well as digital printing solutions and colour management tools. Kodak GCG is a leader in prepress technology and have received 16 Graphic Arts Technology Foundation (GATF) InterTech Technology Awards. With headquarters in Rochester, NY, USA, the company serves customers around the globe with regional offices in the United States, Europe, Japan, Asia Pacific and Latin America.

[www.kodak.com](http://www.kodak.com)

### manroland

**manroland AG** is the world's second largest printing systems manufacturer and the world's market leader in web offset. manroland employs almost 8 700 people and has annual sales of some Euro 1,7 billion with an export share of 80%. Web fed and sheetfed presses provide solutions for publishing, commercial, and packaging printing.

[www.man-roland.com](http://www.man-roland.com)



**MEGTEC Systems** is the world's largest supplier of weblines and environmental technologies for web offset printing. The company is a specialised system supplier for roll and web handling (loading systems, pasters, infeeds) and web drying and conditioning (hot air dryers, oxidisers, chill rolls). MEGTEC combines these technologies with in depth process knowledge and experience in coldset and heatset printing. MEGTEC has manufacturing and R&D facilities in the US, France, Sweden and Germany, China and India along with regional sales, service and parts centres. MEGTEC also provides energy and efficiency consulting and machine upgrades.

[www.megtec.com](http://www.megtec.com)



**Muller Martini** a globally active group of companies is the leader in the development, manufacture and marketing of a broad range of print finishing systems. Since its foundation in 1946 the family-owned business has focused exclusively on the graphic arts industry. Today, the company is segmented into seven operating divisions: Printing Presses, Press Delivery Systems, Saddle Stitching Systems, Softcover Production, Hardcover Production, Newspaper Mailroom Systems and OnDemand Solutions. Customers rely on a worldwide manufacturing, sales and service network of approximately 4 000 employees. Subsidiaries and representatives provide Muller Martini products and services in all countries of the world.

[www.mullermartini.com](http://www.mullermartini.com)



**Nitto Denko Corporation** is one of the world's specialist suppliers of polymer processing and precision coating. The company was formed in Japan in 1918 and employs 12 000 people all over the world. Nitto Europe NV is a subsidiary, which was founded in 1974 and is the group's leading supplier to the paper and printing industries with products like repulpable double-coated adhesive tapes for splicing systems. Nitto has also become the reference supplier to offset and gravure printers worldwide. Nitto Europe NV is ISO 9001 certified.

[www.nittoeurope.com](http://www.nittoeurope.com), [www.permacel.com](http://www.permacel.com), [www.nitto.co.jp](http://www.nitto.co.jp)

### QuadTech.

**QuadTech** is a worldwide leader in the design and manufacture of control systems that help commercial, newspaper, publication and packaging printers improve their performance, productivity and bottom line results. The company offers an extensive range of auxiliary controls, including its best-selling register guidance systems (RGS), the award-winning Color Control System (CCS) and the widely-known Autotron. QuadTech, founded in 1979, is a subsidiary of Quad/Graphics and is based in Wisconsin, USA. The company was ISO 9001 registered in 2001.

[www.quadtechworld.com](http://www.quadtechworld.com)



**SCA** (Svenska Cellulosa Aktiebolaget) is a global consumer goods and paper company that develops, produces and markets personal care products, tissue, packaging solutions, publication papers and solid wood products. Sales are conducted in 90 countries. SCA has annual sales in excess of SEK 101 billion (c. € 11 billion) and production facilities in more than 40 countries. SCA had approximately 51 000 employees at the beginning of 2007. SCA has a range of high grade, customised publication papers for newspapers, supplements, magazines, catalogues and commercial printing.

[www.sca.com](http://www.sca.com), [www.publicationpapers.sca.com](http://www.publicationpapers.sca.com)



**Sun Chemical** is the world's largest producer of printing inks and pigments. It is a leading provider of materials to packaging, publication, coatings, plastics, cosmetics, and other industrial markets. With annual sales over \$3 billion and 12 500 employees, Sun Chemical supports customers around the world and operates 300 facilities throughout North America, Europe, Latin America and the Caribbean. The Sun Chemical Group of companies includes such well-known names as Coates Lorilleux, Gibbon, Hartmann, Kohl & Madden, Swale, Usher-Walker and US Ink.

[www.sunchemical.com](http://www.sunchemical.com), [www.dic.co.jp](http://www.dic.co.jp)



**Trelleborg Printing Blankets** is a product area within Trelleborg Coated Systems. Trelleborg is a global industrial group whose leading positions are based on advanced polymer technology and in-depth applications know-how. Trelleborg develops high-performance solutions that seal, damp and protect in demanding industrial environments. Trelleborg is represented in the printing industry with its brands Vulcan™ and Rollin™. With the market knowledge grown over many years combined with innovative technology, patented processes, vertical integration and total quality management, servicing 60 countries on five continents, both brands can be considered among market leaders worldwide, providing offset printing blankets for the web, sheetfed, newspaper, business forms, metal decorating and packaging markets. Its European production sites are certified with ISO 9001, ISO 14001 and EMAS certifications.

[www.trelleborg.com](http://www.trelleborg.com)



www.wocg.info **e-TOOLBOX**

Members

www.kodak.com

www.man-roland.com

www.megtec.com

www.mullermartini.com

www.nittoeurope.com,  
www.permacel.com,  
www.nitto.co.jp

www.quadtechworld.com

www.sca.com,  
www.publicationpapers.sca.com

www.sunchemical.com,  
www.dic.co.jp

www.trelleborg.com

In association with